



OPERATION AND SERVICE MANUAL

MODEL 4280A
1MHz C METER/C-V PLOTTER
(Including Option 001)

SERIAL NUMBERS

This manual applies directly to instruments with serial numbers prefixed 2346J.

With changes described in Section VII, this manual also applies to instruments with serial numbers prefixed 2315J.

For additional important information about serial numbers, see INSTRUMENTS COVERED BY MANUAL in Section I.

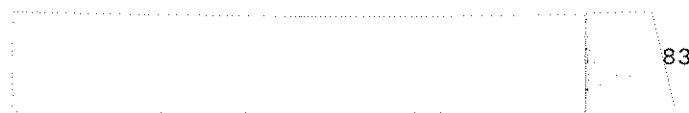

SECTION I GENERAL INFORMATION

1-1. INTRODUCTION

1-2. This operation and service manual contains the information required to install, operate, test, adjust, and service the Hewlett-Packard Model 4280A 1MHz C Meter/C-V Plotter. Figure 1-1 shows the 4280A and its supplied accessories. This section covers specifications, instrument identification, description, options, accessories, and other basic information.

1-3. Listed on the title page of this manual is a microfiche part number. This number can be used to order 4x6 inch microfilm transparencies of the manual. Each microfiche contains up to 60 photo-duplicates of the manual pages. The microfiche package also includes the latest manual changes supplement as well as all pertinent service notes. To order an additional manual, use the part number listed on the title page of this manual.

1-4. DESCRIPTION

1-5. The Hewlett-Packard Model 4280A 1MHz C Meter/C-V Plotter is a fully automatic, high performance test instrument designed to measure the C-V and C-t characteristics of semiconductor devices and materials. Basic measurement accuracy is 0.1%, and measurement resolution is 1fF on the most sensitive range. Measured capacitance and conductance values are displayed on the front panel with 4-1/2 digit resolution (5-1/2 digits on option 001 units). The 4280A has a precision timer, a built-in dc bias source, whose output can be swept in a staircase manner, and an automatic error correction function to ensure accurate, repeatable measurements. The high speed C-t measurement capability of the 4280A permits measurement of rapidly changing capacitance, making it possible to analyze a semiconductor's physical characteristics over a wider range of energy levels. The 4280A is

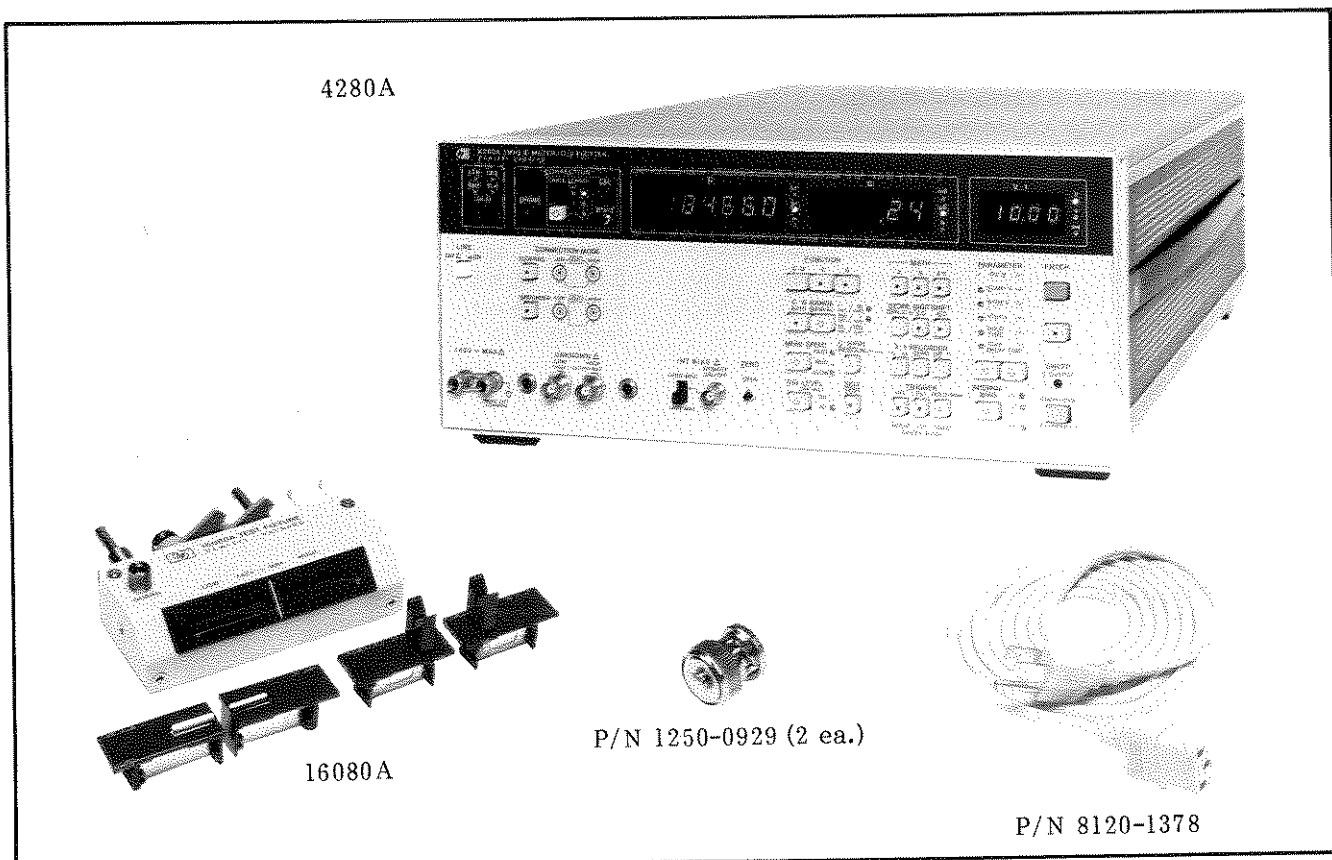

Figure 1-1. Model 4280A and Accessories

capable of both grounded and floating measurements. The test signal is a 1MHz sine wave, and test signal level can be set to 30mVrms or 10mVrms to suit the characteristics of the device under test. The measurement terminals are a two-terminal pair configuration, which, when properly connected to the device under test, eliminates mutual inductance between test leads and reduces the effects of environmental noise. The two-terminal pair configuration is ideally suited to measurements requiring pulsed biasing.

The built-in dc bias source has an output capability of 0 to $\pm 100V$, with 1mV setting resolution on the most sensitive range. For C-V characteristics measurements the bias voltage can be swept in either a single staircase (\uparrow) or double staircase ($\uparrow\downarrow$) fashion. Initial hold time and step delay time from 3ms to 650s can be set to allow the device under test to stabilize at each voltage step before measurement is made.

For C-t characteristics measurements, time intervals (time between readings) from 10 μ s to 32s can be set to suit the characteristics of virtually any semiconductor device. Since the interval between adjacent measurements begins at the mid point of one integration period and ends at the mid point of the next integration period, a true picture of the device's transient characteristics can be obtained.

1-6. An important feature of the 4280A is its ability to accurately measure fast capacitance transients. With pulsed biasing from the internal dc bias source, transients as short as 10ms can be measured. If an external pulse generator is used, though, 10 μ s transients can be measured. Even minute changes in capacitance can be measured with 1fF resolution. Three MATH functions-- Δ , %, $\Delta\%$ --make it possible to measure the relationship between a measured value and a user-stored reference value-- C_{OX} , for example.

1-7. The 4280A measures the capacitance, C, and conductance, G, of the device under test as functions of constant dc bias, swept dc bias, or time after application of a bias pulse. Three measurement functions--C-G, C, and G--and three measurement modes--C, C-V, and C-t--can be selected.

Measurement Functions:

C-G Function: 4280A measures both C and G.

C Function: 4280A measures C only.

G Function: 4280A measures G only.

Measurement Modes:

C Mode:

4280A measures the parameter(s) of the selected function at a constant dc bias voltage supplied from either the internal dc bias source or an external source.

C-V Mode:

4280A measures the parameter(s) of the selected function at each step of a swept bias voltage supplied from the internal dc bias source.

C-t Mode:

4280A measures the parameter(s) of the selected function at a programmed interval after a bias pulse has been applied from either the internal dc bias source or an external pulse generator.

1-8. All instrument operations--measurement, front panel control settings, ranging, triggering, HP-IB, displays, self test, etc.--are controlled by an MC6802 microprocessor. The built-in self test function can be initiated at any time to verify correct operation of the instrument's basic capabilities.

1-9. The Hewlett-Packard Interface Bus (HP-IB) is standard on the 4280A. All instrument functions (except power ON/OFF, INT BIAS switch, and SMOOTHING switch) can be remotely controlled from an HP-IB compatible controller. Measurement data can be output in two formats--ASCII or binary--and two transfer modes--standard or block. Block data transfer mode significantly reduces data transfer time for C-V and C-t measurements. When set to TALK ONLY mode, the 4280A can send measurement data to an external device (a printer, for example) without a controller. An X-Y recorder can be connected to the 4280A's RECORDER OUTPUTS to plot C-V or C-t characteristics.

1-10. SPECIFICATIONS

1-11. Complete specifications of the Model 4280A are given in Table 1-1. These specifications are the performance standards or limits against which the instrument is tested. The test procedures for verifying the specifications are covered in Section IV, Performance Tests. Table 1-2 lists supplemental performance characteristics. Supplemental performance characteristics are not specifications but are typical characteristics included as additional information for the operator. When the 4280A is shipped from the factory, it meets the specifications listed in Table 1-1.

1-12. SAFETY CONSIDERATIONS

1-13. The Model 4280A has been designed to conform to the safety requirements of an IEC (International Electromechanical Committee) Safety Class I instrument and is shipped from the factory in a safe condition.

1-14. This operating and service manual contains information, cautions, and warnings which must be followed by the user to ensure safe operation and to maintain the instrument in a safe condition.

1-15. INSTRUMENTS COVERED BY MANUAL

1-16. Hewlett-Packard uses a two-section nine character serial number which is stamped on the serial number plate (Figure 1-2) attached to the instrument's rear panel. The first four digits and the letter are the serial prefix and the last five digits are the suffix. The letter placed between the two sections identifies the country where the instrument was manufactured. The prefix is the same for all identical instruments; it changes only when a change is made to the instrument. The suffix, however, is assigned sequentially and is different for each instrument. The contents of this manual apply to instruments with the serial number prefix(es) listed under SERIAL NUMBERS on the title page.

1-17. An instrument manufactured after the printing of this manual may have a serial number prefix that is not listed on the title page. This unlisted serial number prefix indicates the instrument is different from the one described in this manual. The manual for this newer instrument may be accompanied by a yellow Manual Changes supplement or have a different manual part number. This supplement contains "change information" that explains how to adapt the manual to the newer instrument.

1-18. In addition to change information, the supplement may contain information for correcting errors (called Errata) in the manual. To keep this manual as current and accurate as possible, Hewlett-Packard recommends that you periodically request the latest Manual Changes supplement. The supplement for this manual is identified with this manual's print date and part

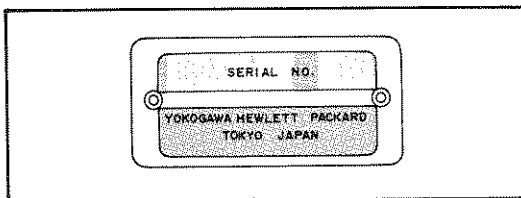

Figure 1-2. Serial Number Plate.

number, both of which appear on the manual's title page. Complimentary copies of the supplement are available from Hewlett-Packard. If the serial prefix or number of an instrument is lower than that on the title page of this manual, see Section VII, Manual Changes.

1-19. For information concerning a serial number prefix that is not listed on the title page or in the Manual Change supplement, contact the nearest Hewlett-Packard office.

1-20. OPTIONS

1-21. Options are modifications to the standard instrument that implement the user's special requirements for minor functional changes. The 4280A has five options:

- Option 001 : C High Resolution
- Option 907 : Front Handle Kit
- Option 908 : Rack Flange Kit
- Option 909 : Rack Flange and Front Handle Kit
- Option 910 : Extra Manual

1-22. OPTION 001

Option 001 equips the standard 4280A with a high resolution capacitance measurement capability that increases display resolution to 5 1/2 digits. Capacitance values up to 190pF can be measured with 1fF resolution; capacitance values up to 1.2nF, with 10fF resolution.

1-23. OTHER OPTIONS:

The following options provide the mechanical parts necessary for rack mounting and hand carrying:

- Option 907: Front Handle Kit. Furnishes carrying handles for both ends of the front-panel.
- Option 908: Rack Flange Kit. Furnishes flanges for rack mounting.
- Option 909: Rack Flange and Front Handle Kit. Furnishes front handles (Opt. 907) and rack flanges (Opt. 908).

Installation instructions for these options are given in Section II.

- Option 910: Adds an extra copy of the Operation and Service Manual.

Table 1-1. Specifications (Sheet 1 of 18)

SPECIFICATIONS

COMMON SPECIFICATIONS

Parameters Measured: Capacitance, C, and conductance, G

Measurement Circuit Mode: Parallel ()

Measurement Modes:

C Mode:

Measures C-G, C, or G with a constant bias voltage supplied from the internal dc bias source or an external source.

C-V Mode:

Measures C-G, C, or G as a function of swept (staircase) dc bias voltage supplied from the internal dc bias source.

C-t Mode:

Measures C-G, C, or G at a programmed interval after a bias pulse has been applied from either the internal dc bias source or an external pulse generator.

Measurement Speed:

FAST, MED, or SLOW in C and C-V modes; FAST or MED in C-t Mode

Display: 4-1/2 digits, 5-1/2 digits on Option 001 units

Parameter	Maximum Display
C	-19000 to +19000
G	-12000 to +12000

Number of display digits depends on the test signal level and the measurement speed. For details, refer to Figures 3-5 and 3-6.

DIGIT SHIFT:

Number of display digits can be decreased by pressing a DIGIT SHIFT key (C \diamond and G \diamond).

Measurement Terminals: Two-terminal pair configuration with guard terminal

Range Modes: Auto and Manual

Connection Modes: Fourteen selectable connection modes. Refer to Table A.

Test Signal:

Frequency: 1MHz \pm 0.01%

Level: 30mVrms \pm 10%, or 10mVrms \pm 10%

Test Signal Level is specified at the UNKNOWN terminals with both terminals open terminated.

Table 1-1. Specifications (Sheet 2 of 18)

Error Correction:

Provides compensation for measurement errors caused by the residuals and strays of the measurement cables and the test fixture.

CABLE LENGTH Adjustment:

0m: Compensation for measurement errors caused by a direct connection type test fixture (e.g., HP 16080A)

1m: Compensation for measurement errors caused by HP 16082A 1m test leads.

0 - 5m:

Compensation for measurement errors caused by test leads up to 5m long made from standard coaxial cable (P/N: 8120-4195)

ZERO OPEN Adjustment:

Compensates for the stray capacitance and conductance (admittance) of the test fixture.

MATH Functions: Δ, %, and Δ%

Measurement Ranges:

10pF/100μs, 100pF/1mS, 1nF/10mS; maximum display value and maximum number of display digits for each range depend on MEAS SPEED and SIG LEVEL. Refer to the following table.

MEAS SPEED	SIG LEVEL	Measurement Range		
		10pF 100μS	100pF 1mS	1nF/ 10mS
FAST	10mV	19.00pF/ 120.0μS	190.0pF/ 1.200mS	1.900nF/ 12.00mS
	30mV			
MED	10mV*	19.000pF/ 120.00μS	190.00pF/ 1.2000mS	1.9000nF/ 12.000mS
	30mV			
SLOW	10mV	19.000pF/ 120.00μS	190.00pF/ 1.2000mS	1.9000nF/ 12.000mS
	30mV			

Maximum values given in the table above are uncorrected measurement values. They apply only when the internal error correction is disabled.

When error correction is enabled, maximum values will decrease due to the strays of the measurement circuit. For grounded connection modes, the 10pF/100μS range cannot be used. Maximum capacitance values for the 100pF/1mS range and 1nF/10mS are approximately 50pF and 1760pF, respectively, because the stray capacitance of grounded connection modes is approximately 140pF (not specified).

*: Number of output digits via the HP-IB is 4-1/2. However, accuracy of the least significant digit is not specified.

SELF TEST: Verifies correct operation of the 4280A's basic functions.

Table 1-1. Specifications (Sheet 3 of 18)

Internal DC Bias:Output: 0V to $\pm 100V$

Ranges: 1V, 10V, and 100V

Ranging Modes: Auto and Fixed

Range and Ranging Mode are determined by the V LIMIT value set in C Mode. When V LIMIT = 0, Auto ranging mode is selected; when V LIMIT \neq 0, range is fixed at the range most appropriate for the V LIMIT value. Output voltage resolution and accuracy depend on range. Refer to the following tables.

Auto Ranging Mode (V LIMIT = 0):

Voltage Range	Range Coverage	Resolution	Accuracy*
1V	$\pm(0.000 \text{ to } 1.999)V$	1mV	$\pm(0.2\% + 0.01V)$
10V	$\pm(2.00 \text{ to } 19.99)V$	10mV	$\pm(0.1\% + 0.02V)$
100V	$\pm(20.0 \text{ to } 100.0)V$	100mV	$\pm(0.1\% + 0.1V)$

* Accuracy is calculated as $\pm(\% \text{ of setting} + \text{offset})$.

Fixed Ranging Mode (V limit \neq 0):

V Limit	Voltage Range	Range Coverage
0.001 to 1.999	1V	$\pm(0.000 \text{ to } V \text{ Limit})V$
2.00 to 19.99	10V	$\pm(0.00 \text{ to } V \text{ Limit})V$
20.0 to 100.0	100V	$\pm(0.0 \text{ to } V \text{ Limit})V$

Accuracy and resolution for each range are the same as those in Auto Ranging Mode.

External Bias:

Maximum voltage and current:

 $\pm 42V$, $\pm 100mA$ via EXT BIAS SLOW or EXT BIAS FAST

Table 1-1. Specifications (Sheet 4 of 18)

HP-IB Interface:

Data output and remote control. Based on IEEE Std. 488 and ANSI-MC1.1.

Interface Capabilities:

SH1, AH1, T5, L4, SR1, RL1, DC1, DT1, and E1

Remote Control:

All front panel control settings (except LINE ON/OFF switch, INT BIAS limit switch, and REMOTE ON/OFF switch)

Data Output:

Measurement status, measured values, display status, and LEARN mode data. Data can be output in ASCII format or binary format. Data can be transferred in standard mode or block mode.

Recorder Outputs:**C·G and G connectors:**

DC voltage proportional to the number of counts on the C (or G) and G displays, respectively. Full scale output is $\pm 10V$, 10mV/count.

V·t connector:

DC voltage proportional to time in C or C-t mode, or to the internal bias voltage in C-V mode. Full scale output is $\pm 10V$, 20mV/trigger in C mode, 20mV/reading in C-t mode, 20mV/step in C-V mode.

Accuracy:

$\pm(0.5\% + 20mV)$ for C connector and G connector outputs, and $\pm(0.5\% + 40mV)$ for V·t connector output

PEN LIFT:

TTL level output for UP/DOWN control of an X-Y recorder's pen

SMOOTHING Switch:

Sets an initial wait time to allow the recorder's pen to move to the first plot point before the PEN DOWN signal is sent and sets the time constant of the smoothing filter.

Warm-up Time: ≥ 30 minutes

Ambient Temperature:

0 °C to 55 °C

However, if the 4280A is set to FUNCTION C or G and FAST MEAS SPEED, the Ambient Temperature Range is 0 °C to 40 °C.

Table 1-1. Specifications (Sheet 5 of 18)

Table A. Connection Modes

DC Bias Sample	Internal DC Bias Source	Internal and External DC Bias Sources		External Fast Pulse Generator* ³ and Inter- nal or External DC Bias Source		None
FLOATING	CN10* ₁ 	CN11 	CN12 	CN13 	CN14 	CN21* ₄
GROUNDED	CN15* ₂ 	CN16 	CN17 	X		CN22* ₄
	CN18 	CN19 	CN20 			CN23* ₄

*1: Set when the FLOATING key is pressed.

*2: Set when the GROUNDED key is pressed.

*3: Used when delay time, t_d , for a high speed C-t measurement is less than $200 \mu s$.

*4: L-R measurement. Used when test lead impedance is to be measured for error correction.

Table 1-1. Specifications (Sheet 6 of 18)

C MODE

Measurement Functions: C-G, C, and G

Operational Parameter: DC bias (DC V)

Connection Modes: CN10 to CN20

Trigger: Internal, External, Manual, or HP-IB remote control

Internal DC Bias Source Modes: == (dc bias) and OFF

Measurement Accuracies:

Sample	Connection Mode	Accuracy
FLOATING	CN10 to CN12	See Table 1.
	CN13 and CN14	See Table 2.
GROUNDED	CN15 to CN20	See Table 3.

Accuracies given in the following tables are specified under the following conditions:

- (1) Warm-up time: ≥ 30 minutes
- (2) Ambient temperature:
 $23^{\circ}\text{C} \pm 5^{\circ}\text{C}$ (at 0°C to 18°C and 28°C to 55°C temperature ranges, error doubles)
- (3) CABLE LENGTH is 0m or 1m, ZERO OPEN has been performed, and CORRECTION function is ENABLED (key indicator lamp is lit).
- (4) Capacitance between each measurement terminal and the guard terminal is 0.
- (5) For C accuracy, $D < 0.05$ ($D < 0.01$ in C mode); for G accuracy, C (display counts) $< C_{FS}/100$

$$D: G/(2\pi \times 10^6 \times C)$$

C_{FS} : full scale C value

- (6) When the 16082A (1m) test leads are used, add C (pF)/10000 [%] of C reading and G (mS)/50[%] of G reading to the C and the G accuracies, respectively.
- (7) EXT BIAS FAST connector terminated with $50\Omega \pm 1\%$ for connection modes CN13 and CN14.

Table 1-1. Specifications (Sheet 7 of 18)

When the measurement function is C or G, the additional errors listed in Tables B and C must be added to the accuracies listed in Tables 1, 2 and 3.

Table B. Additional C Error (C Function)

Sample	Connection Mode	C Additional Error
FLOATING	CN10 to CN12	$0.05\% \text{ of rdg} + \frac{G}{20} \text{ counts}^{*1}$
	CN13 and CN14	$0.2\% \text{ of rdg} + \frac{G}{20} \text{ counts}^{*2}$
GROUNDING	CN15 to CN20	$(10 + \frac{G}{20}) \text{ counts}$

G: Number of counts on the G display in C-G mode, without error correction

- *1: At 0 °C to 18 °C and 28 °C to 55 °C, error doubles and 0.1% of reading must be added.
- *2: Applicable only when the measured C value is less than 200pF.
- *3: When MEAS SPEED is set to FAST, measurement accuracy is not specified if the ambient temperature exceeds 40 °C.

Table C. Additional G Error (G Function)*1

Sample	Connection Mode	G Additional Error
FLOATING	CN10 to CN12	$0.05\% \text{ of rdg} + \frac{C}{50} \text{ counts}$
	CN13 and CN14	$0.2\% \text{ of rdg} + \frac{C}{50} \text{ counts}$
GROUNDING	CN15 to CN20	$(10 + \frac{C}{50}) \text{ counts}$

C: Number of counts on the C display in C-G mode, without error correction

- *1: Table C is applicable only when the measured G value is less than 2mS.
- *2: When MEAS SPEED is set to FAST, measurement accuracy is not specified if the ambient temperature exceeds 40 °C.

Table 1-1. Specifications (Sheet 8 of 18)

Table 1. C-G Accuracy (CN10 to CN12)

SIG LEVEL	Parameter	Measurement Range		
		10pF/100µS	100pF/1mS	1nF/10mS
30mVrms	C	±(0.1% of rdg + 5 counts)	±(0.1% of rdg + 3 counts)	±(0.1% of rdg + 3 counts)
	G	±(0.2% of rdg + 5 counts)	±(0.2% of rdg + 3 counts)	±(1.2% of rdg + 3 counts)
10mVrms	C	±(0.2% of rdg + 5 counts)	±(0.2% of rdg + 3 counts)	±(0.2% of rdg + 3 counts)
	G	±(0.3% of rdg + 5 counts)	±(0.3% of rdg + 3 counts)	±(1.2% of rdg + 3 counts)

Table 2. C-G Accuracy (CN13 and CN14)

SIG LEVEL	Parameter	Measurement Range		
		10pF/100µS	100pF/1mS	1nF/10mS
30mVrms	C	±(0.4% of rdg + 20 counts)	±(0.4% of rdg + 13 counts)	±(1.4% of rdg + 23 counts)
	G	±(0.5% of rdg + 20 counts)	±(0.5% of rdg + 13 counts)	±(2.5% of rdg + 23 counts)
10mVrms	C	±(0.5% of rdg + 20 counts)	±(0.5% of rdg + 13 counts)	±(1.5% of rdg + 23 counts)
	G	±(0.6% of rdg + 20 counts)	±(0.6% of rdg + 13 counts)	±(2.5% of rdg + 23 counts)

Table 3. C-G Accuracy (CN15 to CN20)

SIG LEVEL	Parameter	Measurement Range		
		10pF/100µS	100pF/1mS	1nF/10mS
30mVrms	C	—————	±(0.3% of rdg + 30 counts)	±(0.3% of rdg + 10 counts)
	G	—————	±(0.4% of rdg + 30 counts)	±(1.4% of rdg + 10 counts)
10mVrms	C	—————	±(0.4% of rdg + 30 counts)	±(0.4% of rdg + 10 counts)
	G	—————	±(0.5% of rdg + 30 counts)	±(1.4% of rdg + 10 counts)

Table 1-1. Specifications (Sheet 9 of 18)

C-V MODE

Measurement Functions: C-G-V, C-V, and G-V

Operational Parameters:

START V: Internal bias sweep start voltage. -100V to +100V

STOP V: Internal bias sweep stop voltage. -100V to +100V

STEP V: Internal bias sweep step voltage

STEP V Range	Resolution
0V to 3.999V	1mV
4.00V to 39.99V	10mV
40.0V to 200.0V	100mV

When internal bias sweep starts, STEP V will be rounded to match the START V/STOP V setting resolution.

HOLD TIME:

Hold time before and after the internal bias sweep. See Figures 1 and 2.

HOLD TIME Range	Resolution
3ms to 65ms	1mS
0.07s to 99.99s	10mS
100.0s to 650.0s	100mS

STEP DELAY TIME:

Delay time for each internal bias STEP V. See Figures 1 and 2.

STEP DELAY TIME Range	Resolution
3ms to 65ms	1ms
0.07s to 99.99s	10ms
100.0s to 650.0s	100ms

Connection Modes: CN10, CN11 and CN12 for Floating measurements
CN15, CN16 and CN20 for Grounded measurements

Table 1-1. Specifications (Sheet 10 of 18)

Sweep Modes:

SINGLE: Performs the internal bias sweep measurement once.

EXT: Performs the internal bias sweep measurement each time the instrument is externally triggered.

REPEAT: Performs the internal bias sweep measurement repeatedly.

Internal Bias Modes:

\uparrow (single staircase sweep) and $\uparrow\downarrow$ (double staircase sweep)

Measurement Accuracies: Same as those for C Mode.

Table 1-1. Specifications (Sheet 11 of 18)

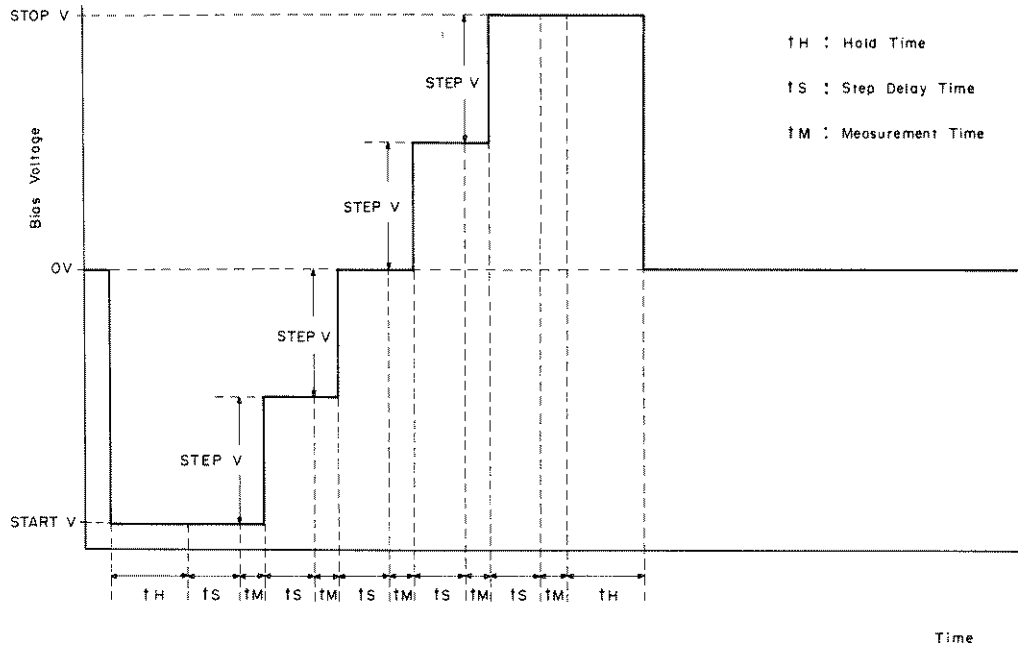

Figure 1. C-V Mode (\square Bias Sweep)

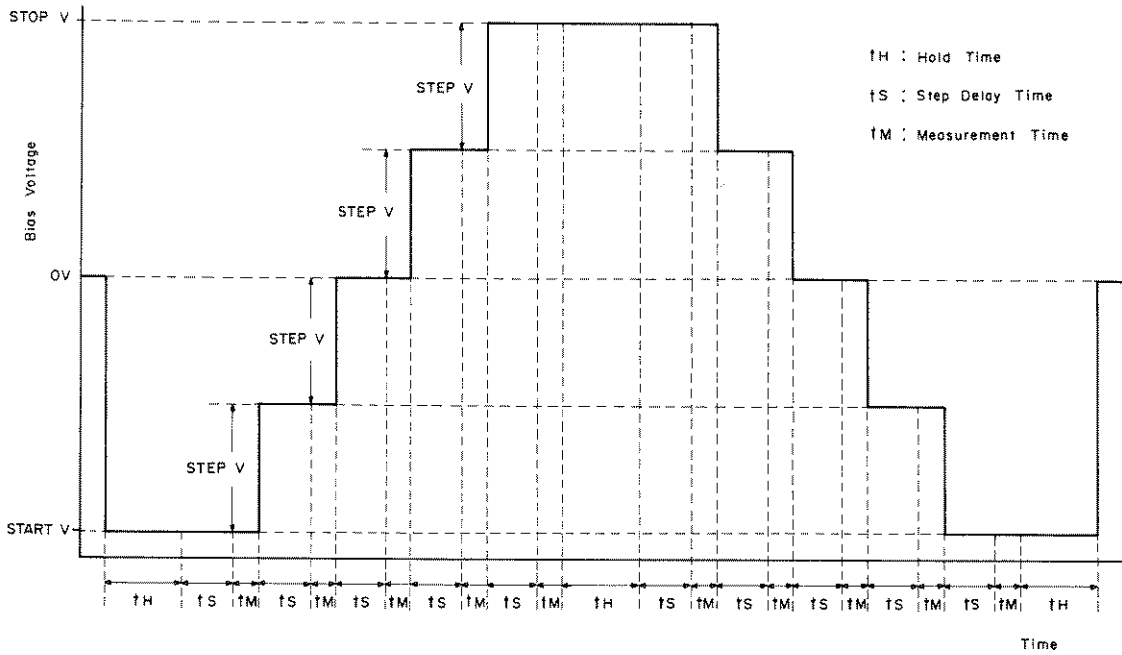

Figure 2. C-V Mode (\square Bias Sweep)

Table 1-1. Specifications (Sheet 12 of 18)

C-t MODE

Measurement Functions: C·G-t, C-t, and G-t

Bias Modes:

INT:

C-t measurement with bias supplied from the internal dc bias source

EXT SLOW:

Slow C-t measurement with bias supplied from an external pulse generator

EXT FAST:

Fast C-t measurement with bias supplied from an external pulse generator

Integration Modes:

BURST:

One bias pulse is applied to the sample, then C and G are measured the specified number of times (NO. OF READINGS) at a user-specified measurement interval (td). See Figure 3.

SAMPLING:

A bias pulse is repeatedly applied to the sample and C and G are measured one user-specified measurement interval (td) after each bias pulse.

In INT Bias mode, BURST integration mode is automatically selected. Integration mode is automatically selected in accordance with the user-specified measurement interval (td). It is also selectable via the HP-IB.

Operational Parameters:

DC V: Output from the internal dc bias source

PULSE V: Bias pulse from the internal dc bias source

MEAS V:

Output from the internal dc bias source after PULSE V. C and G are measured at this bias voltage.

NO OF READINGS:

Number of measurement point is 1 to 9999. In SAMPLING INTEGRATION MODE, MAXIMUM NO OF READINGS is $5/td[s]$.

th: Bias pulse width. The following table lists range and resolution.

Table 1-1. Specifications (Sheet 13 of 18)

th Range	Resolution
10 μ s to 65ms	10 μ s
66ms to 1s	500 μ s
1s to 10s	1ms
10s to 32s	10ms

Minimum and maximum th depend on Bias Mode and Integration Mode.

INT Bias Mode: 10ms to 32s

EXT SLOW Bias Mode: 50 μ s to 32s

EXT FAST Bias Mode: 10 μ s to 32s

SAMPLING Integration Mode:

Maximum th depends on MEAS SPEED. Refer to the following table.

MEAS SPEED	Maximum th
FAST	500 \cdot td
MED	200 \cdot td (C \cdot t/G-t measurement) 100 \cdot td (C \cdot G-t measurement)

td: Measurement interval. Resolution is the same as that of th.

BURST Integration Mode: td range is listed in the following table.

Measurement Function	MEAS SPEED	HP-IB Data Transfer Format		
		BLOCK	Standard	
			BINARY	ASCII*
C-t or G-t	FAST	10ms to 32s	20ms to 32s	150ms to 32s
	MED	50ms to 32s	200ms to 32s	
C \cdot G-t	FAST		200ms to 32s	
	MED	100ms to 32s	250ms to 32s	

*: td range when the 4280A is in local operation is the same as that of ASCII HP-IB operation.

Table I-1. Specifications (Sheet 14 of 18)

SAMPLING Integration Mode:

EXT SLOW Bias Mode: 200 μ s to 5s

EXT FAST Bias Mode: 10 μ s to 5s

Connection Modes:

Bias Modes	Sample	Connection Mode
INT	FLOATING	CN10, CN11, CN12
	GROUNDING	CN15, CN16, CN20
EXT SLOW	FLOATING	CN11, CN12
	GROUNDING	CN17, CN19
EXT FAST	FLOATING	CN13, CN14
	GROUNDING	-

SWEEP MODE:

SINGLE:

Performs one C-t measurement cycle when the SWEEP/V OUTPUT key is pressed.

EXT:

Performs one C-t measurement cycle when the 4280A is externally triggered.

REPEAT:

Repeatedly performs the C-t measurement cycle until the SWEEP/V OUTPUT key is pressed a second time.

INTERNAL BIAS Modes:

INT: \square (pulse bias)

EXT SLOW: \equiv (dc bias) or OFF

EXT FAST: \equiv (dc bias) or OFF

Table 1-1. Specifications (Sheet 16 of 18)

Measurement Accuracies:

C-t Mode accuracies are specified under the same conditions as those for C Mode accuracies.

BURST Integration Mode: Same as C Mode accuracies.

SAMPLING Integration Mode:

Add the errors in Table 4 to the BURST Integration Mode accuracy.

Table 4. SAMPLING Mode Additional Errors

SIG LEVEL	Additional Error *
30mVrms	$5/t_0$ [% of rdg] + (20 + 300/ t_0) [counts]
10mVrms	$5/t_0$ [% of rdg] + (20 + 900/ t_0) [counts]

*: t_0 in Table 4 is equal to $k \cdot t_d$, where t_d is the user-specified measurement interval (in μ s) and k is an integer that represents a measurement point (between 1 and NO OF READINGS).

Note

Depending on the measurement time and the ambient temperature, add the following error. t_1 is equal to $k \cdot t_d$ and its unit is in seconds. Ignore this error if t_1 is less than 1s or the ambient temperature is lower than 23 °C.

$$1.5 \times t_1 \times 2^{\Delta T/10} \text{ [counts]}$$

$$\Delta T = (\text{Ambient Temperature}) - 23 \text{ [}^\circ\text{C]}$$

Table 1-1. Specifications (Sheet 17 of 18)

OPTIONS**Option 001:**

High resolution C measurement capability. Increases C display resolution by one digit. Applicable on the 100pF and 1nF ranges.

C-OFFSET:**MEASURED:**

Automatically sets the displayed measured value as the offset capacitance value.

MANUAL:

Offset capacitance value can be keyed in with the front panel numeric keys. Offset capacitance values from 0pF to 1023pF can be set in increments of 1pF. Minimum and maximum allowable offset values depend on measurement range and the capacitance of the device under test. Refer to the following table. Conditions are listed below:

- (1) The sample's capacitance must be measurable on the range listed in column A.
- (2) Sample's capacitance minus offset capacitance must be measurable on the range listed in column B.

Allowable Offset	A	B
0pF to 19pF	10pF Range	10pF Range
20pF to 190pF	100pF Range	10pF Range
191pF to 1023pF	1nF Range	100pF Range

Measurement Range:

MEAS SPEED	SIG LEVEL	C·G RANGE	
		100pF/1mS	1nF/10mS
SLOW	30mVrms	0.000pF to 190.000pF 0.00μS to 120.00μS	0.00000nF to 1.20000nF* 0.0000mS to 1.2000mS
	10mVrms		
MED	30mVrms	0.00pF to 190.00pF 0.0μS to 120.0μS	0.0000nF to 1.2000nF* 0.000mS to 1.200mS
	10mVrms		
FAST	30mVrms	0.00pF to 190.00pF 0.0μS to 120.0μS	0.0000nF to 1.2000nF* 0.000mS to 1.200mS
	10mVrms		

*: Approximate value

Table 1-1. Specifications (Sheet 18 of 18)

- Option 907: Front Handle Kit (hp 5061-0090)
- Option 908: Rack Flange Kit (hp 5061-0078)
- Option 909: Rack Flange and Handle Kit (Combines Options 907 and 908)
(hp 5061-0084)
- Option 910: Extra Operation and Service Manual

GENERAL SPECIFICATIONS

Operating Temperature: 0 °C to 55 °C

Relative Humidity: 70% at 40 °C

Power Requirements: 90V to 132V, 198V to 250V. 48Hz to 66Hz

Power Consumption: 140VA max with option 001 installed

Dimensions:

Approx. 426 (W) x 177 (H) x 498 (D)mm

Excludes feet, fan cover, terminals and keys

Weight: Approx. 15.3kgs. 15.6kgs. with option 001

ACCESSORIES SUPPLIED

Test Fixture:

16080A Test Fixture. Includes three kinds of contact inserts.

BNC Shorting Cap: hp 1250-0929. 2EA.

Power Cord: hp 8120-1378

Line Fuse:

hp 2110-0304 (100V/120V)

hp 2110-0360 (220V/240V)

ACCESSORIES AVAILABLE

HP-IB Cable:

HP 10833A (1m) HP 10833C (4m)

HP 10833B (2m) HP 10833D (0.5m)

Test Fixtures and Test Leads:

Refer to Table 1-3.

Table 1-2. Supplemental Performance Characteristics (Sheet 1 of 6)

SUPPLEMENTAL PERFORMANCE CHARACTERISTICS

Supplemental Performance Characteristics are for reference purposes only. They are not guaranteed specifications.

COMMON CHARACTERISTICS

Measurement Accuracy when $1 > D > 0.05$: Add $D/10\%$ of reading.

When the connection mode is CN13 or CN14, however, add $D/2\%$ of reading for measurements made on the $10\text{pF}/100\mu\text{S}$ and $100\text{pF}/1\text{mS}$ ranges, and add $D\%$ of reading for measurements made on the $1\text{nF}/10\text{mS}$ range.

Measurement Accuracy when $D \geq 1$:

Multiply the measurement accuracies listed in Table 1-1 by $(1 + D^2)$

G Accuracy when displayed $C > C_{FS}/100$:

Add $C/250$ counts for measurements made on the $100\mu\text{S}$ and 1mS ranges, and add $C/100$ counts for measurements made on the 10mS range.

C: Counts on the C display

C_{FS} : Full scale counts

Test signal Level:

Actual test signal level applied to the device under test depends on the capacitance of the device and the length of the test leads. See Figure 1.

L-R Measurement Function:

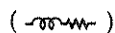
Measures the inductance and resistance of short-terminated test cables. ()

Connection Mode: CN21, CN22 and CN23

Measurement Range:

L: $-19.000\mu\text{H}$ to $+19.000\mu\text{H}$

R: -190.00Ω to $+190.00\Omega$

There are no unit indicator lamps for L-R measurements.

Measurement Accuracy:

Measurement conditions are the same as C mode's.

L: $\pm[0.5\%$ of reading + $(20 + R_c/500)$ counts]

R: $\pm[1.2\%$ of reading + $(10 + L_c/500)$ counts]

L_c and R_c are C and G display counts, respectively.

Residual Impedance of 16080A Test Fixture:

Radial lead type contact inserts: Approx. 70nH , Approx. $50\text{m}\Omega$

Axial lead type contact inserts: Approx. 90nH , Approx. $50\text{m}\Omega$

Table 1-2. Supplemental Performance Characteristics (Sheet 2 of 6)

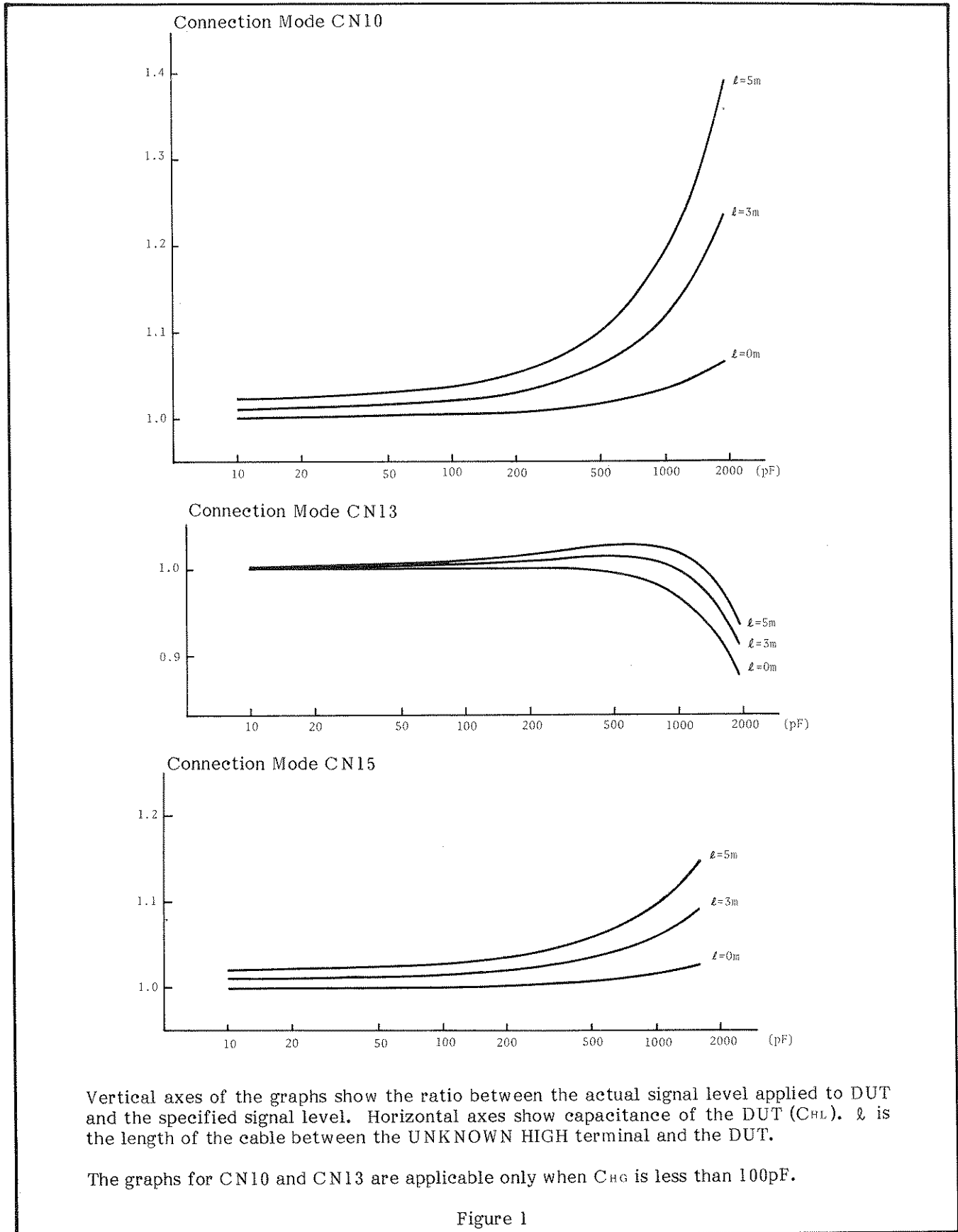

Figure 1

Table 1-2. Supplemental Performance Characteristics (Sheet 3 of 6)

Additional error caused by Test Leads:

Figure 2 shows the additional C and G errors that result when the HP 16081A cable (2m long) or a 1m, 3m, 4m or 5m cable made from 8120-4195 coaxial cable is used.

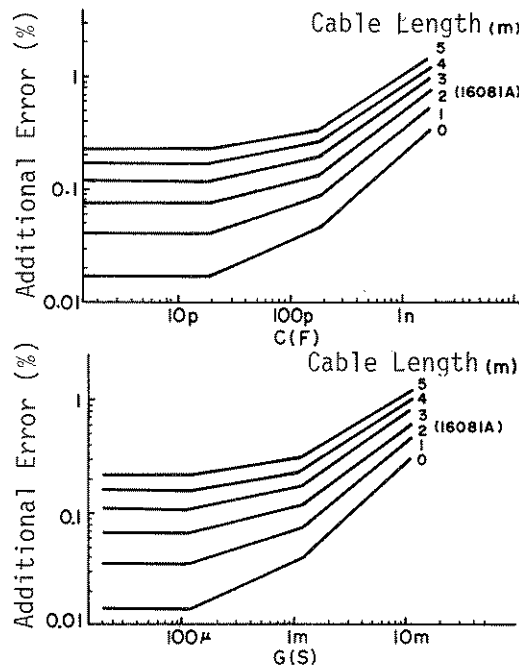

Figure 2

Internal Error Correction Time:

Approx. 60ms (Approx. 30ms for a C only or G only measurement)

MATH (Δ , %, $\Delta\%$) Calculation Time:

Approx. 20ms. (Approx. 10ms for a C only or G only measurement)

Initial Setting Time: Approx. 650ms

Ranging Time: Approx. 100ms

Test Signal Level Settling Time: Approx. 40ms

Connection Mode Change Time: Approx. 110ms

Analog Circuit Response Time:

Approx. 50μs. In C-t mode, if elapsed time (delay time x measurement point) is less than 10ms when FAST MEAS SPEED is selected, or if less than 100ms when MED MEAS SPEED is selected, response time is as short as 1μs for EXT FAST bias mode and 6μs for EXT SLOW bias mode.

Table 1-2. Supplemental Performance Characteristics (Sheet 4 of 6)

Maximum Offset Voltage:

$\pm 1\text{mV}$. For C-t measurements with external bias, $\pm(10\text{mV} + 1\text{mV}/^\circ\text{C})$

Maximum Input Resistance:

20Ω . For C-t measurements with external bias, refer to the following table.

	Measurement Range		
	10pF/100 μ S	100pF/1mS	1nF/10mS
During Hold Time	20 Ω		
During Measurement	200 Ω	20 Ω	15 Ω

Maximum Allowable Current:

100mA. For C-t measurements with external bias, refer to the following table.

	Measurement Range		
	10pF/100 μ S	100pF/1mS	1nF/10mS
During Hold Time	100mA		
During Measurement	0.3mA	3mA	20mA

Internal DC Bias:

Bias Voltage Settling Time:

Approx. $(0.05 \times \Delta V + 1.7)\text{ms}$. ΔV is the voltage change in volts.

Ranging Time: Approx. 10ms

Maximum Output Current: $\pm 6\text{mA}$

Output Resistance: Approx. 10 Ω

SET/RESET Time: Approx. 120ms

Bias Voltage Setting Change Time:

Approx. 120ms in == mode when voltage is being output.

Table 1-2. Supplemental Performance Characteristics (Sheet 5 of 6)

C MODE

Measurement Time:

Table 1 lists typical times. All times listed are in milliseconds.

Table 1. Measurement Time

MEAS SPEED	Measurement Function		
	C-G	C	G
FAST	30 (70)	10 (30)	10 (30)
MED	70 (110)	40 (60)	35 (55)
SLOW	400 (440)	270 (290)	220 (240)

When measured values are displayed on the front panel and the recorder outputs are used, measurement times in parentheses apply.

C-V MODE

Measurement Time: Calculated as follows:

$$t_h \times 2 + (t_d + \text{C-G Measurement Time}^{*1}) \times \left(\frac{|\text{STOP V} - \text{START V}|}{\text{STEP V}} + 1 \right)^{*2}$$

*1: Refer to Table 1.

*2: Drop all digits to the right of decimal point.

Hold Time/Step Delay Time Accuracies:

≤65ms: ±(0.02% of setting + 100ns + internal bias settling time)

>65ms: ±(0.02% of setting + 10ms + internal bias settling time)

C-t MODE

Measurement Time:

Typical values are calculated as follows:

BURST Integration Mode:

$$t_h + t_d \times (\text{NO OF READINGS})$$

Table 1-2. Supplemental Performance Characteristics (Sheet 6 of 6)

SAMPLING Mode:

Measurement time in SAMPLING Integration Mode increases with each reading, and depends on pulse width, MEAS SPEED, and $k \cdot t_d$, where t_d is measurement interval and k is an integer representing a given measurement point. Refer to Figure 3 to calculate measurement time for C-t and G-t measurements. Measurement time doubles for C-G-t measurements.

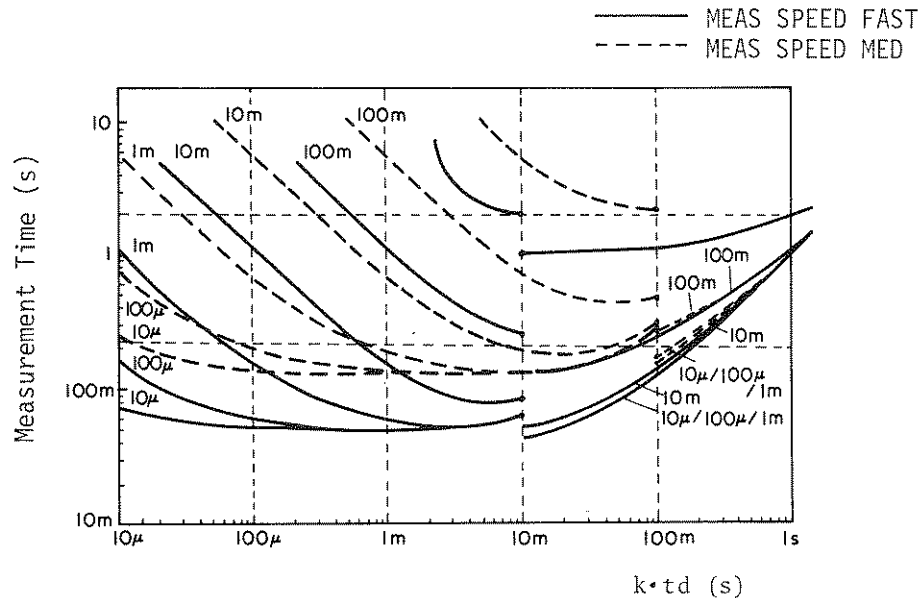

k : Measurement Point. $k = 1, 2, \dots, N$ (=NO OF READINGS).
 t_d : Measurement Interval

Numbers in the figure represent t_h (s).

Figure 3

t_h and $k \cdot t_d$ Accuracies:

- ≤65ms: ±(0.02% of setting + 100ns* + internal bias settling time)
- >65ms: ±(0.02% of setting + 0.5ms + internal bias settling time)

*10μs for C-t measurements that use the internal dc bias source

For C-G-t measurements in BURST integration mode, add 10 to 100ms delay for the G measurement.

External Bias Response Time: Approx. 100μs in EXT SLOW mode.

OPTIONS

Option 001:

ON/OFF Switching Time: Approx. 350ms

C-OFFSET Accuracy:

1 to 1023pF: ±(2% of setting + 0.5pF)

1-24. ACCESSORIES SUPPLIED

1-25. The standard 4280A 1MHz C Meter/C-V Plotter, along with its furnished accessories, is shown in Figure 1-1. The furnished accessories are also listed below:

- 16080A Test Fixture
(Refer to Table 1-3 for a brief description)
- Power Cable HP P/N 8120-1378
- BNC Shorting Caps HP P/N 1250-0929
2 ea.
- Fuse HP P/N 2110-0304
or 2110-0360

1-26. ACCESSORIES AVAILABLE

1-27. In addition to the furnished 16080A Test Fixture, two special purpose test leads are available. Each is intended for a particular measurement, and each was designed with careful consideration to accuracy, reliability, ease of use, and compatibility with other HP instruments. A brief description of each available accessory is given in Table 1-3.

Table 1-3. Accessories Available (Sheet 1 of 2)

MODEL	DESCRIPTION
<p>16080A (furnished)</p> 	<p>Test Fixture (direct attachment type) for measurements of either axial- or radial-lead components. Three kinds of contact inserts are furnished:</p> <ul style="list-style-type: none"> ① For axial-lead components, (P/N: 16061-70022) ② For general radial-lead components, (P/N: 16061-70021) ③ For radial short-lead components, (P/N: 16047-65001) <p>DC bias up to $\pm 42V$ can be applied.</p>
<p>16081A</p> 	<p>Test Leads (two-terminal pair), double-shielded, with BNC connectors for connecting the 4280A to a wafer prober or a user-fabricated test fixture. Supplied with a connector plate (P/N 16081-60000) and a BNC-to-BNC cable (P/N 16081-61600) for REMOTE ON/OFF control of the internal dc bias source.</p> <p>Cable Length: 2m</p>
<p>16082A</p> 	<p>Test Leads (two-terminal pair) with BNC connectors for connecting the 4280A to a wafer prober or a user-fabricated test fixture. Supplied with a connector plate (P/N 16081-60000) and a BNC-to-BNC cable (P/N 16053-61003) for REMOTE ON/OFF control of the internal dc bias source.</p> <p>Cable Length: 1m</p>

Table 1-3. Accessories Available (Sheet 2 of 2)

MODEL	DESCRIPTION
<p data-bbox="175 310 267 338">16083A</p> 	<p data-bbox="829 310 1425 512">Pulse Bias Noise Clipper. Eliminates baseline noise from the output of an external pulse generator (required for High-speed C-t measurements), thereby minimizing fluctuation of measurement results. The 16083A also provides pulse bias voltage and current monitoring capabilities.</p>

SECTION II INSTALLATION

2-1. INTRODUCTION

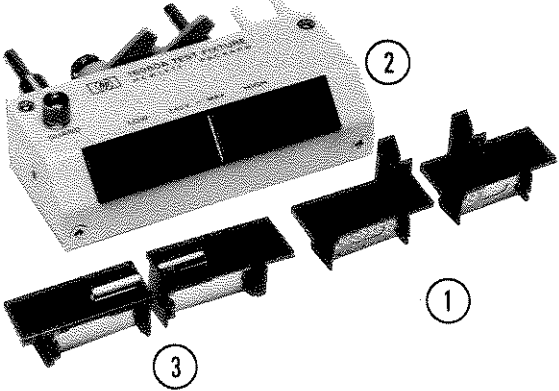
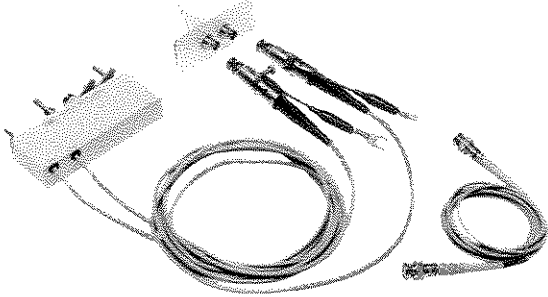
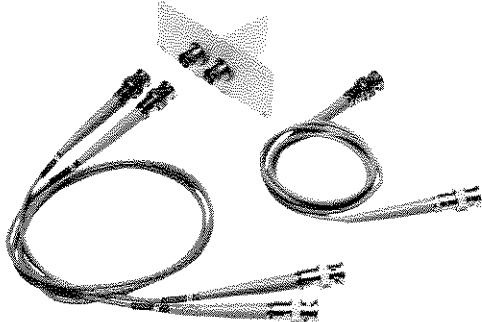
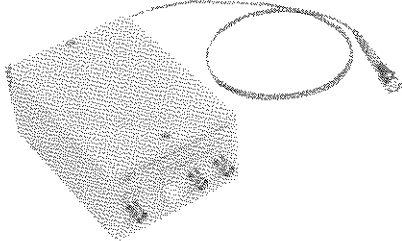
2-2. This section provides installation instructions for the Model 4280A 1MHz C Meter/C-V Plotter. It also includes information on initial inspection and damage claims, on preparation for using the 4280A, and on packaging, storage, and shipment.

2-3. INITIAL INSPECTION

2-4. The 4280A 1MHz C Meter/C-V Plotter, when shipped from the factory, meets all the specifications listed in Table 1-1. Upon receipt, inspect the shipping container for damage. If the shipping container or cushioning material is damaged, it should be kept until the contents of the shipment have been checked for completeness and the instrument has been checked mechanically and electrically. The contents of the shipment should be as shown in Figure 1-1. The procedures for checking the general electrical operation are given in Section III (paragraph 3-7 SELF TEST) and the procedures for checking the 4280A 1MHz C Meter/C-V Plotter against its specifications are given in Section IV. First, do the self test. If the 4280A is electrically questionable, then do the Performance Tests to determine whether the 4280A has failed or not.

If the shipment is incomplete, if the contents show any sign of mechanical damage or other defects (scratches, dents, broken switches, etc.), or if the instrument does not pass the self test or performance tests, notify the nearest Hewlett-Packard office (see list at back of this manual). The HP office will arrange for repair or replacement without waiting for claim settlement.

2-5. PREPARATION FOR USE

2-6. POWER REQUIREMENTS

2-7. The 4280A requires a power source of 100, 120, 220 Volts ac $\pm 10\%$, or 240 Volts ac $+5\%$ - 10% , 48 to 66Hz single phase; power consumption is 140VA maximum.

WARNING

IF THE INSTRUMENT IS TO BE ENERGIZED VIA AN EXTERNAL AUTOTRANSFORMER FOR VOLTAGE REDUCTION, BE SURE THE COMMON TERMINAL IS CONNECTED TO THE NEUTRAL POLE OF THE POWER SOURCE.

2-8. LINE VOLTAGE AND FUSE SELECTION

2-9. Figure 2-1 provides instructions for line voltage and fuse selection. The 4280A is shipped from the factory with the fuse and LINE VOLTAGE SELECTOR switch setting appropriate for the geographic area in which the instrument will be used.

CAUTIONS

- (1) BEFORE TURNING ON THE 4280A, VERIFY THAT THE LINE VOLTAGE SELECTOR SWITCH IS CORRECTLY SET FOR THE LINE VOLTAGE BEING USED. USE A FUSE PROPER FOR THE SELECTED LINE VOLTAGE.
- (2) USE ONLY REPLACEMENT FUSES OF THE CORRECT CURRENT RATING AND OF THE SPECIFIED TYPE. DO NOT USE MENDED FUSES, AND DO NOT SHORT CIRCUIT THE FUSE HOLDERS.

2-10. POWER CABLE

2-11. To protect operating personnel, the National Electrical Manufacturers Association (NEMA) recommends that the instrument panel and cabinet be grounded. The 4280A is equipped with a three-conductor power cable which, when plugged into an appropriate receptacle, grounds the instrument. The offset pin on the power cable is the ground wire.

2-12. To preserve the protection feature when operating the instrument from a two contact outlet, use a three prong to two prong adapter (HP Part No. 1251-8196) and connect the green grounding tab on the adapter to power line ground.

CAUTION

THE MAINS PLUG MUST ONLY BE INSERTED IN A SOCKET OUTLET PROVIDED WITH A PROTECTIVE EARTH CONTACT. THE PROTECTIVE ACTION MUST NOT BE NEGATED BY THE USE OF AN EXTENSION CORD (POWER CABLE) WITHOUT PROTECTIVE CONDUCTOR (GROUNDING).

2-13. Figure 2-2 shows the available power cords for use in various countries including the standard power cord furnished with the instrument. HP Part number, applicable standards for power plug, power cord color, electrical characteristics and countries using each power cord are listed in the figure. If assistance is needed for selecting the correct power cable, contact the nearest Hewlett-Packard office.

2-14. INTERCONNECTIONS

2-15. To interconnect the 4280A to an external controller or peripheral device using the HP-IB interface capability (IEEE Std. 488/ANSI-MC1.1), connect an HP-IB interface cable between the HP-IB connector on the rear panel of the 4280A and the HP-IB connector on the peripheral device. Refer to paragraph 3-164 for details on the HP-IB.

When external (pulse) bias is to be used, connect the external (pulse) bias source to the EXT BIAS connectors (FAST or SLOW) and SYNC OUTPUT connector. Refer to paragraph 3-102 for details on external (pulse) biasing.

When an external trigger device is used, connect the trigger device to the EXT TRIGGER connector.

To monitor the bridge waveform, connect an oscilloscope to the I-V CONVERTER OUTPUT and Z AXIS connectors.

When an X-Y recorder is used, connect the RECORDER OUTPUTS connectors (located on the 4280A's rear panel) to the X and Y axes connectors of the X-Y recorder. If the X-Y recorder is equipped with remote TTL pen lift control, connect the 4280A's PEN LIFT terminal to the X-Y recorder's pen lift terminal. Refer to paragraph 3-156 for details on using an X-Y recorder.

2-16. OPERATING ENVIRONMENT

2-17. Temperature. The instrument may be operated in temperatures from 0 °C to +55 °C.

2-18. Humidity. The instrument may be operated in environments with relative humidities up to 70% at 40 °C. However, the instrument must be protected from temperature extremes which cause condensation within the instrument.

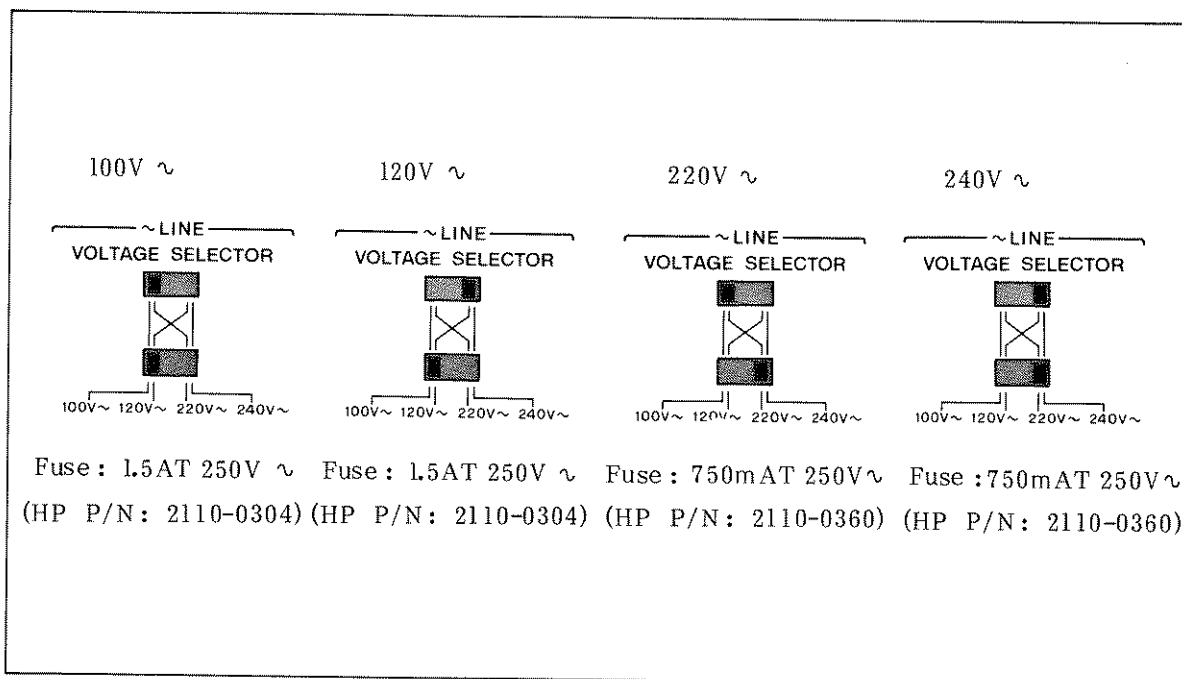

Figure 2-1. Voltage and Fuse Selection

<p>OPTION 900 United Kingdom</p>  <p>Earth Neutral Line</p> <p>Plug : BS 1363A, 250V Cable : HP 8120-1351</p>	<p>OPTION 901 Australia/New Zealand</p>  <p>Earth Neutral Line</p> <p>Plug : NZSS 198/AS C112, 250V Cable : HP 8120-1369</p>
<p>OPTION 902 European Continent</p>  <p>Earth Line Neutral</p> <p>Plug : CEE-VII, 250V Cable : HP 8120-1689</p>	<p>OPTION 903 U.S./Canada</p>  <p>Earth Line Neutral</p> <p>Plug : NEMA 5-15P, 125V, 15A Cable : HP 8120-1378</p>
<p>OPTION 905** Any country</p>  <p>Line Neutral Earth</p> <p>Plug : CEE 22-VI, 250V Cable : HP 8120-1396</p>	<p>OPTION 906 Switzerland</p>  <p>Neutral Earth Line</p> <p>Plug : SEV 1011.1959-24507 Type 12, 250V Cable : HP 8120-2104</p>
<p>OPTION 912 Denmark</p>  <p>Line Neutral Earth</p> <p>Plug : DHCR 107, 220V Cable : HP 8120-2956</p>	<p>* In the U.S.A. a 230-volt mains might not include a neutral conductor. In this case it is recommended that the blue conductor of the standard power cord be connected to the terminal normally used for neutral (line 1).</p> <p>** Plug option 905 is frequently used for interconnecting system components and peripherals.</p>
<p>NOTE : Each option number includes a ' family ' of cords and connectors of various materials and plug body configurations (straight, 90 ° etc.).</p>	

Figure 2-2. Power Cables Supplied

2-19. INSTALLATION INSTRUCTIONS

2-20. The HP Model 4280A can be operated on a bench or in a rack mount. The 4280A is ready for bench operation as shipped from the factory. For bench operation, the 4280A is equipped with two retractable stands which are mounted on the instrument's bottom cover. To use the stands, pull each one away from the bottom cover until it locks into position.

2-21. Installation of Options 907, 908 and 909

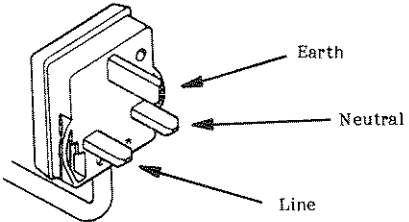
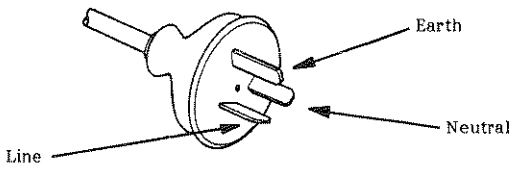
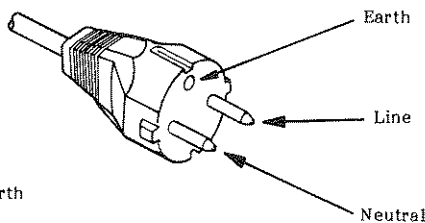
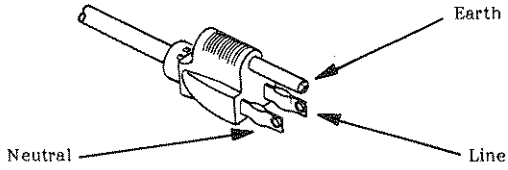
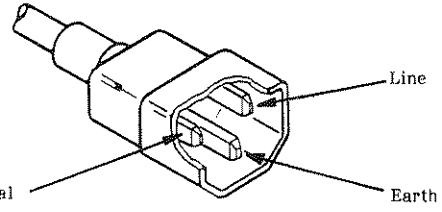
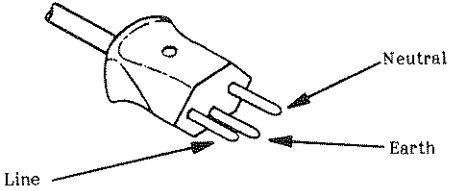
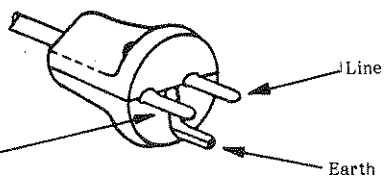
2-22. The 4280A can be rack-mounted and operated as part of a measurement system. Rack mounting information for the 4280A is given in Figure 2-3.

2-23. STORAGE AND SHIPMENT

2-24. ENVIRONMENT

2-25. The instrument may be stored or shipped in environments within the following limits:

Temperature	-55 °C to +75 °C
Humidity	to 95% at 40 °C

The instrument must be protected from temperature extremes which cause condensation inside the instrument.

2-26. PACKAGING

2-27. Original Packaging. Containers and materials identical to those used in factory packaging are available from Hewlett-Packard.

If the instrument is being returned to Hewlett-Packard for servicing, attach a tag indicating the type of service required, return address, model number, and full serial number. Also mark the container FRAGILE to assure careful handling. In any correspondence, refer to the instrument by model number and full serial number.

2-28. Other Packaging. The following general instructions should be used for re-packing with commercially available materials:

- a. Wrap instrument in heavy paper or plastic. If shipping to a Hewlett-Packard office or service center, attach a tag indicating the type of service required, return address, model number, and full serial number.
- b. Use a strong shipping container. A double-wall carton made of 350 pound test material is adequate.
- c. Use enough shock absorbing material (3- to 4-inch layer) around all sides of instrument to provide a firm cushion and to prevent movement inside the container. Protect the front panel with cardboard.
- d. Seal the shipping container securely.
- e. Mark the shipping container FRAGILE to ensure careful handling.
- f. In any correspondence, refer to the instrument by model number and full serial number.

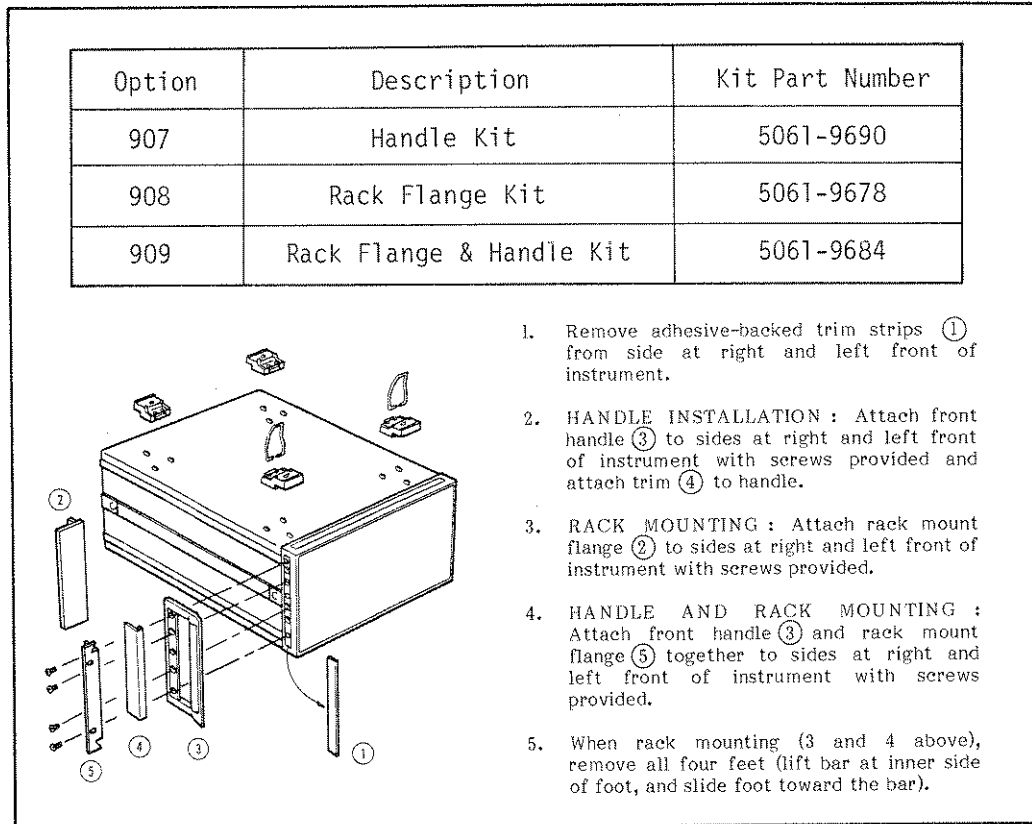

Figure 2-3. Rack Mount Kit

SECTION III OPERATION

3-1. INTRODUCTION

3-2. This section provides all the information necessary to operate the Model 4280A 1MHz C METER/C-V PLOTTER. Included are descriptions of the front and rear-panel controls, displays, lamps and connectors; discussions on operating procedures and measurement techniques for various applications; and instructions on the instrument's SELF TEST function. Warnings, Cautions, and Notes are given throughout; they should be observed to insure the safety of the operator and the serviceability of the instrument.

PROTECTIVE EARTH GROUNDED SOCKET. ANY INTERRUPTION OF THE PROTECTIVE EARTH GROUNDING WILL CAUSE A POTENTIAL SHOCK HAZARD THAT COULD RESULT IN SERIOUS PERSONAL INJURY.

ONLY FUSES OF THE CORRECT CURRENT RATING AND OF THE SPECIFIED TYPE SHOULD BE USED. DO NOT USE REPAIRED FUSES OR SHORTED FUSE-HOLDERS. TO DO SO COULD CAUSE A SHOCK OR FIRE HAZARD.

WARNING

BEFORE THE INSTRUMENT IS SWITCHED ON, ALL PROTECTIVE EARTH TERMINALS, EXTENSION CORDS, AUTO-TRANSFORMERS AND DEVICES CONNECTED TO IT SHOULD BE CONNECTED TO A

CAUTION

BEFORE THE INSTRUMENT IS SWITCHED ON, IT MUST BE SET TO THE VOLTAGE OF THE POWER SOURCE (MAINS), OR DAMAGE TO THE INSTRUMENT MAY RESULT.

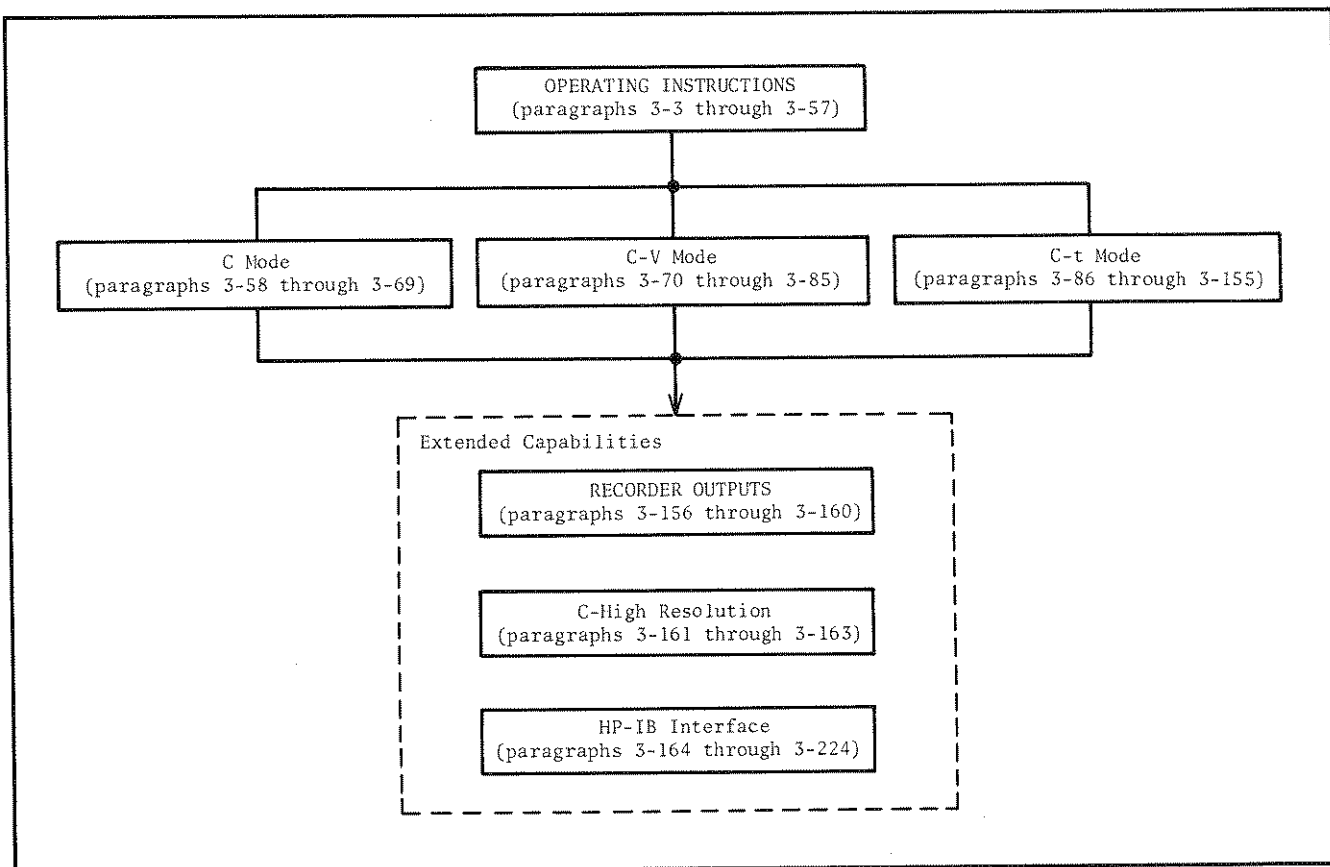

Figure 3-1. Contents of Section III

3-3. OPERATING INSTRUCTIONS

3-4. Operating instructions for the instrument's basic capabilities are given in paragraphs 3-3 through 3-57. Operating instructions for Extended Capabilities (X-Y Recorder Outputs, C-High Resolution measurement, remote operation via the HP-IB) are covered in paragraphs 3-156 through 3-224.

3-5. PANEL FEATURES

3-6. Figures 3-2 and 3-3 identify and briefly describe the purpose of each key, indicator, and connector on the front and rear panels, respectively. Detailed information on front panel displays and controls is given starting in paragraph 3-7.

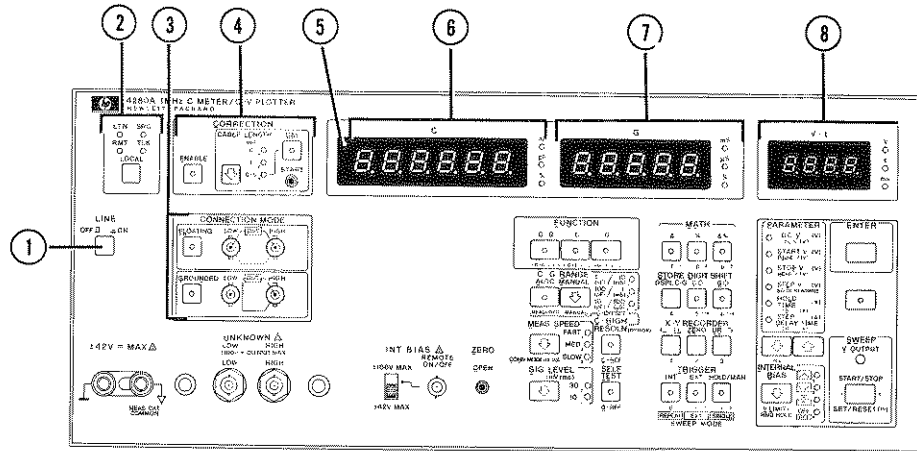

① LINE OFF/ON:

Applies ac line power to the instrument when set to the ON (■) position. Removes ac line power when set to the OFF (□) position.

② HP-IB Status Indicators and LOCAL Key:

These four LED lamps—LTN, SRQ, TLK and RMT (listen, service request, talk and remote, respectively)—indicate the status of the 4280A when it is interfaced with a computer or a listen-only device (printer, for example) via the HP-IB. The LOCAL key, when pressed, releases the instrument from remote (RMT) HP-IB control, enabling front panel control. The LOCAL key is disabled (does not function) when the instrument is set to "local lockout" by the controller.

③ CONNECTION MODE:

These keys change the 4280A's internal circuitry to allow floating or grounded measurements. FLOATING and GROUNDING are the 4280A's basic connection modes. Many more connection modes are also possible. Refer to CONN MODE (34) and paragraph 3-31.

FLOATING:

Pressing this key automatically configures the UNKNOWN terminals (27) for a floating measurement. Connect the DUT as shown in the drawing adjacent to the key.

When this key is pressed, the key indicator lamp comes on and [n 10 (CONNECTION MODE 10) appears on the V-t display (8). (This connection mode can be selected with the CONN MODE (34) key also. The FLOATING key indicator lamp comes on and connection mode code appears on the V-t display.)

GROUNDED:

Similar to the FLOATING key except that the UNKNOWN terminals (27) are configured for a grounded measurement, CONNECTION MODE 15, and [n 15 is displayed on the V-t display. Connect the DUT as shown in the drawing adjacent to the key.

- 4** **CORRECTION:**
- This key group provides internal correction of measurement errors caused by the parasitic elements of the measurement circuit, test fixture, and test leads.
- ENABLE:**
Enables internal correction calculations using stored constants and ZERO OPEN (25) data. When the correction mode is released (ENABLE key indicator lamp off), internal correction calculations are not performed, thus reducing measurement time.
- CABLE LENGTH:**
Selects the nominal cable length for use in the internal correction routines. The selected cable length should agree with the test fixture or test leads connected to the UNKNOWN terminals (27). The lighted indicator lamp shows the selected cable length.
- 0(m): Select this setting when using a direct attachment type test fixture (for example, the furnished 16080A Test Fixture).
- 1(m): Select this setting when using the 16082A one meter test leads.
- 0-5(m): Select this setting when using test leads that are shorter or longer (up to 5m) than one meter (for example, the 16081A two meter test leads or test leads made from PN: 8120-4195 coaxial cable). CABLE LENGTH calibration must be performed.
- CAL and START:**
This key and button function only when the 0-5(m) cable length setting is selected. Pressing CAL lights the key indicator lamp and enables CABLE LENGTH calibration. Pressing the START button initiates the calibration sequence. During calibration, the 4280A measures the capacitance of the cable connected to the UNKNOWN HIGH terminal (27) and stores the results (displayed on the C and G displays) that will be used in the correction calculations. The cable must be open terminated during calibration. At the completion of the calibration sequence, the CAL key indicator lamp will go off automatically. After performing ZERO OPEN (25) the ENABLE key will function normally.
- 5** **Trigger Lamp:**
This lamp comes on each time the instrument is internally, externally, or manually triggered. Trigger mode is set by the TRIGGER keys (18). When INT TRIGGER mode is selected, the trigger lamp flashes at the internal measurement rate.
- 6** **C Display and Unit Indicators:**
Displays measured values of capacitance, the instrument's HP-IB address (at turn on), calculation results (see MATH (14)), calculation reference values (see STORE DISPL (16) and C-REF (33)), C-OFFSET values (option 001 only, see C-HIGH RESOLN (21) AND C-OFFSET (33)), and various messages and error codes (SELF TEST). Maximum number of display digits and maximum display count depend on the type of measurement being made, option installation, and certain control settings. The C display is turned off (blank) for G, G-V, and G-t measurements. Unit indicators (nF, pF, %) show the appropriate unit for the displayed value.
- 7** **G Display and Unit Indicators:**
Displays measured values of conductance, calculation results (see MATH (14)), calculation reference values (see STORE DISPL (16) and G-REF (33)), and messages related to the X-Y RECORDER function (17). Maximum number of display digits and maximum display count depend on the type of measurement being made, and certain control settings. The G display is turned off (blank) for C, C-V, and C-t measurements. Unit indicators (mS, μ S, %) show the appropriate unit for the displayed value.
- 8** **V-t Display and Unit Indicators:**
Displays bias voltage settings, time settings, connection modes, error codes related to illegal operation, and messages for special measurements (for example, $c b L$ for CABLE LENGTH, $\square - \square P$ for ZERO OPEN). Unit indicators (V, s, ms) show the appropriate unit for the displayed value.

Figure 3-2. Front Panel Features (Sheet 2 of 12)

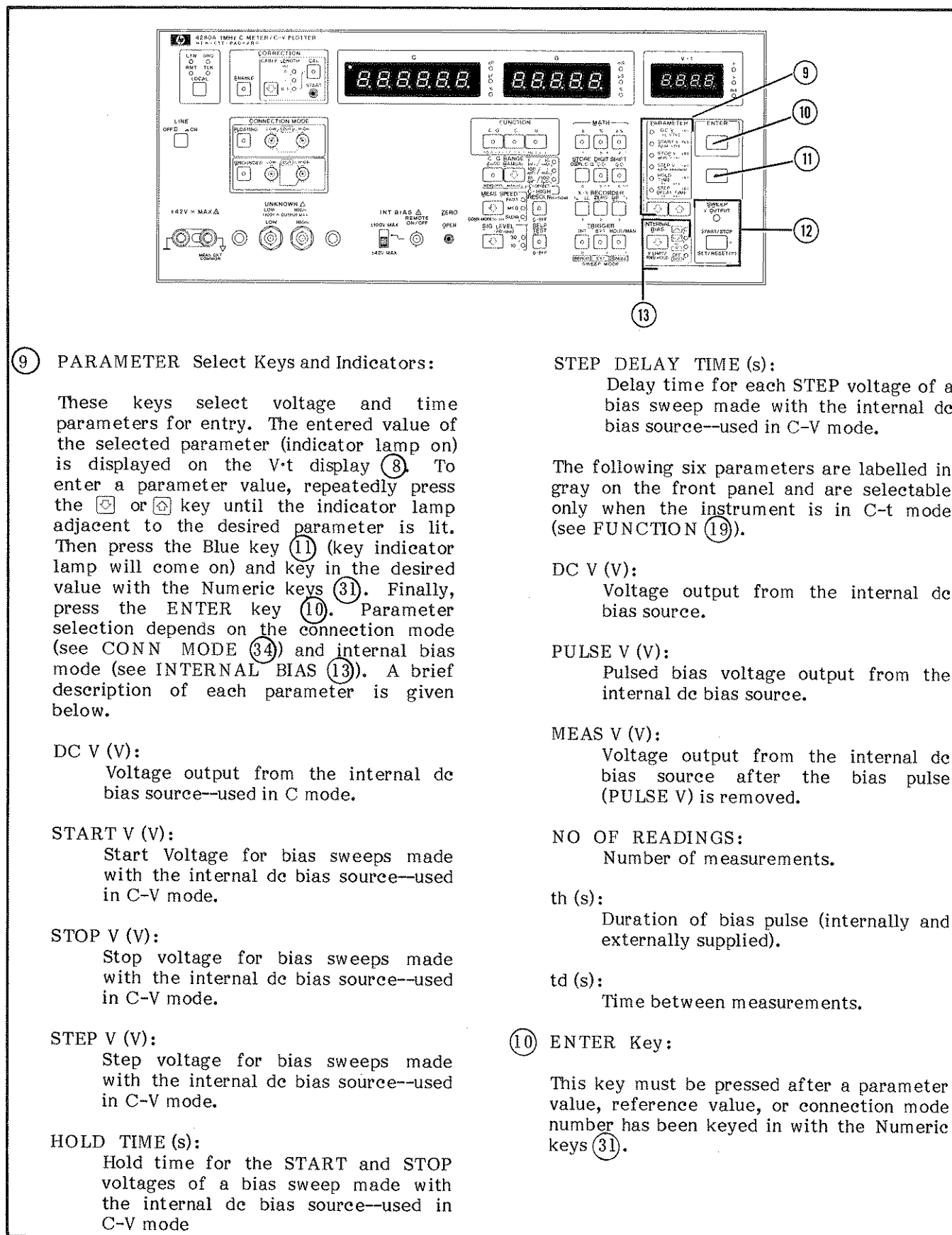

⑨ **PARAMETER Select Keys and Indicators:**

These keys select voltage and time parameters for entry. The entered value of the selected parameter (indicator lamp on) is displayed on the V-t display (8). To enter a parameter value, repeatedly press the \square or \square key until the indicator lamp adjacent to the desired parameter is lit. Then press the Blue key (11) (key indicator lamp will come on) and key in the desired value with the Numeric keys (31). Finally, press the ENTER key (10). Parameter selection depends on the connection mode (see CONN MODE (34)) and internal bias mode (see INTERNAL BIAS (13)). A brief description of each parameter is given below.

DC V (V):

Voltage output from the internal dc bias source--used in C mode.

START V (V):

Start Voltage for bias sweeps made with the internal dc bias source--used in C-V mode.

STOP V (V):

Stop voltage for bias sweeps made with the internal dc bias source--used in C-V mode.

STEP V (V):

Step voltage for bias sweeps made with the internal dc bias source--used in C-V mode.

HOLD TIME (s):

Hold time for the START and STOP voltages of a bias sweep made with the internal dc bias source--used in C-V mode

STEP DELAY TIME (s):

Delay time for each STEP voltage of a bias sweep made with the internal dc bias source--used in C-V mode.

The following six parameters are labelled in gray on the front panel and are selectable only when the instrument is in C-t mode (see FUNCTION (19)).

DC V (V):

Voltage output from the internal dc bias source.

PULSE V (V):

Pulsed bias voltage output from the internal dc bias source.

MEAS V (V):

Voltage output from the internal dc bias source after the bias pulse (PULSE V) is removed.

NO OF READINGS:

Number of measurements.

th (s):

Duration of bias pulse (internally and externally supplied).

td (s):

Time between measurements.

⑩ **ENTER Key:**

This key must be pressed after a parameter value, reference value, or connection number has been keyed in with the Numeric keys (31).

Figure 3-2. Front Panel Features (Sheet 3 of 12)

⑪ Blue Key:

This key must be pressed to access functions labelled in blue. Once pressed, the blue key remains on (key indicator lamp is lit) until a blue function key and the ENTER key **⑩** have been pressed, or until the blue key is pressed again.

⑫ SWEEP/V OUTPUT (Indicator and Key):

The V OUTPUT (red indicator) lamp comes on when the 4280A is performing a biased (internal dc bias source) non-sweep measurement in C mode or a swept (bias or time) measurement in C-V or C-t mode. The SWEEP/V OUTPUT (gold-colored) key (START/STOP-SET/RESET) starts and stops swept measurements in C-V and C-t modes, and sets (turns on) and resets (turns off) the internal dc bias source in C mode. Under certain combinations of measurement mode and connection mode, if INTERNAL BIAS is set to OFF, this key does not function. Operation of this key depends also on the sweep mode (see TRIGGER/SWEEP MODE **⑱**).

Note

The V OUTPUT lamp blinks on and off when the current through the DUT exceeds the output capability of the internal dc bias source.

WARNING

IF V OUTPUT LAMP BLINKS ON AND OFF WHEN NOTHING IS CONNECTED TO THE UNKNOWN TERMINALS, THE 4280A IS MALFUNCTIONING AND DANGEROUS VOLTAGE MAY BE PRESENT AT THE UNKNOWN TERMINALS.

⑬ INTERNAL BIAS Key and Indicators:

This key selects the function of the internal dc bias source and, in some respects, determines the measurement mode. Selectable functions depend on connection mode. Each function is briefly described below.

⌚ (Double Staircase Bias Sweep):

Sets the 4280A to C-V mode. The internal dc bias source will sweep its output in an up-down staircase fashion in accordance with the previously entered sweep parameters.

⌚ (Single Staircase Bias Sweep):

Sets the 4280A to C-V mode. The internal dc bias source will sweep its output in a single staircase fashion in accordance with the previously entered sweep parameters.

== (DC Bias):

Sets the 4280A to C mode (non sweep). The internal dc bias source will output the previously entered bias voltage.

OFF:

Sets the 4280A to C mode (non sweep). Turns off the internal dc bias source.

The following three functions are labelled in gray on the front panel and are selectable only when the instrument is in C-t mode (see FUNCTION **⑲**).

⌚ (Pulsed Bias):

The internal dc bias source outputs a pulse whose height and width are determined by the previously entered PULSE V and th parameters, respectively, and then outputs the specified MEAS V voltage for the remainder of the measurement sequence.

== (DC Bias):

This function is used for connection modes requiring pulsed biasing from an external voltage source. The internal dc bias source outputs the previously entered bias voltage after the bias pulse period (determined by th).

OFF:

Turns off the internal dc bias source.

Figure 3-2. Front Panel Features (Sheet 4 of 12)

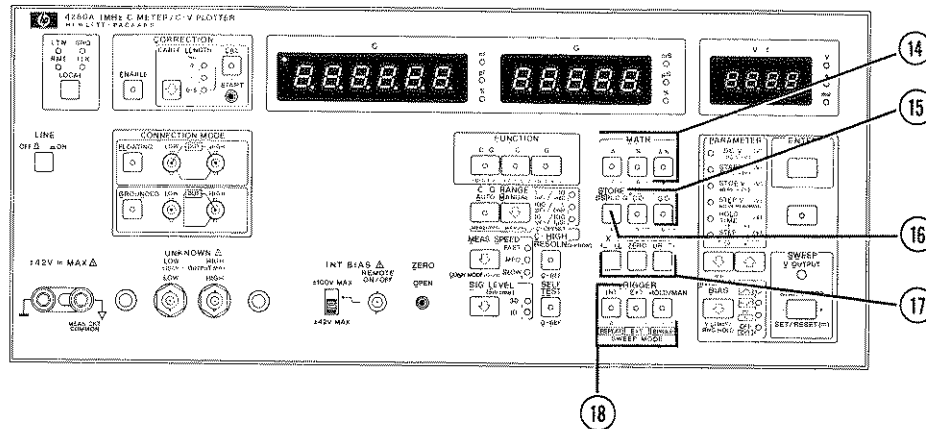

14 MATH Keys:

These keys instruct the 4280A to calculate difference (Δ), percent (%), and percent difference ($\Delta\%$). Once pressed, the key remains on (key indicator lamp on) until it is pressed again or until another MATH key is pressed. When one of these keys is pressed, values displayed on the C display (6) and G display (7) are calculation results, not measured values.

$$\frac{A-B}{B} \times 100 (\%)$$

where A and B are as described in the explanation of the Δ key.

Δ (difference):

Calculates the difference between the measured value of the device under test and a previously stored reference value. The formula used is

$$A - B$$

where A is the measured value of the device under test and B is the stored reference value.

% (percent):

Computes the percentage relationship between the measured value of the device under test and a previously stored reference value. The formula used is

$$\frac{A}{B} \times 100 (\%)$$

where A and B are as described above in the explanation of the Δ key.

$\Delta\%$ (percent difference):

Computes the percent difference between the measured value of the device under test and a previously stored reference value. The formula used is

15 DIGIT SHIFT Keys:

These keys are related to the 4280A's X-Y RECORDER function. They reduce the number of digits displayed on the C display (6) and G display (7) to prevent the G and C-G recorder outputs (11) in Figure 3-3 from saturating. Refer to paragraph 3-156 for details.

C \diamond :

Each time this key is pressed, the least significant digit (right-most digit) of the number appearing on the C display (6) is deleted. The new number is automatically rounded and shifted one display position to the right. Only digits to the right of the decimal point can be deleted. The complete number can be redisplayed by repeatedly pressing this key until the key indicator lamp goes off. This key does not function when the C display is turned off (FUNCTION 19 is set to G).

G \diamond :

Functions identically to the C \diamond key (described above) for numbers appearing on the G display (7). This key does not function when the G display is turned off (FUNCTION 19 is set to C).

Figure 3-2. Front Panel Features (Sheet 5 of 12)

①⑥ STORE DISPL C-G Key:

Pressing this key stores the values displayed on the C display ⑥ and G display ⑦. The stored values are used as reference values in calculations made by the 4280A's MATH functions (MATH ⑭). Previously stored reference values are erased and replaced with displayed values each time this key is pressed. If the C or G display is turned off (FUNCTION ⑰ is set to C or G) when this key is pressed, the previously stored reference value of the turned-off display is not updated.

①⑦ X-Y RECORDER Keys:

These keys are used when setting the lower left, upper right, and absolute zero scaling points on an X-Y recorder connected to the recorder outputs (RECORDER OUTPUTS ①① in Figure 3-3) on the rear panel. They function when TRIGGER ⑱ is set to HOLD/MAN or when the 4280A is in, C-V or C-t mode and is not measuring.

↓ LL(lower left):

When this key is pressed, -10V is output from each recorder output connector on the rear panel. The lower left scaling point (X and Y minimum) on the X-Y recorder can be set.

ZERO (absolute zero):

When this key is pressed, 0V is output from each recorder output connector on the rear panel. The absolute mid-point of the plot area on the X-Y recorder can be set.

UR→ (upper right):

When this key is pressed, +10V is output from each recorder output connector on the rear panel. The upper right scaling point (X and Y maximum) on the X-Y recorder can be set.

①⑧ TRIGGER/SWEEP MODE Select Keys:

These keys select the trigger mode for non-sweep measurements (C mode) and the sweep mode for swept measurements (C-V and C-t modes).

INT:

This key selects internal triggering. Measurement is made at a rate equal to that of the internal trigger signal.

EXT:

This key selects external triggering. An external trigger device or a TTL level trigger signal must be connected to the EXT TRIGGER connector (③ in Figure 3-3) on the rear panel. Measurement is made each time a positive-going TTL level pulse is applied to the center conductor of the connector.

HOLD/MAN:

This key is for manual triggering. Measurement is made each time this key is pressed. Measurement data is held until the key is pressed again.

REPEAT :

When this mode is selected in C-V or C-t mode, (swept) measurements are started by pressing the SWEEP/V OUTPUT key ⑫, and are repeated until the SWEEP/V OUTPUT key is pressed again.

EXT :

When this mode is selected in C-V or C-t mode, single sweep measurement is started by an external trigger signal applied to the EXT TRIGGER connector (③ in Figure 3-3) on the rear panel.

SINGLE :

When this mode is selected in C-V or C-t mode, single sweep measurement is started by pressing the SWEEP/V OUTPUT key ⑫.

Figure 3-2. Front Panel Features (Sheet 6 of 12)

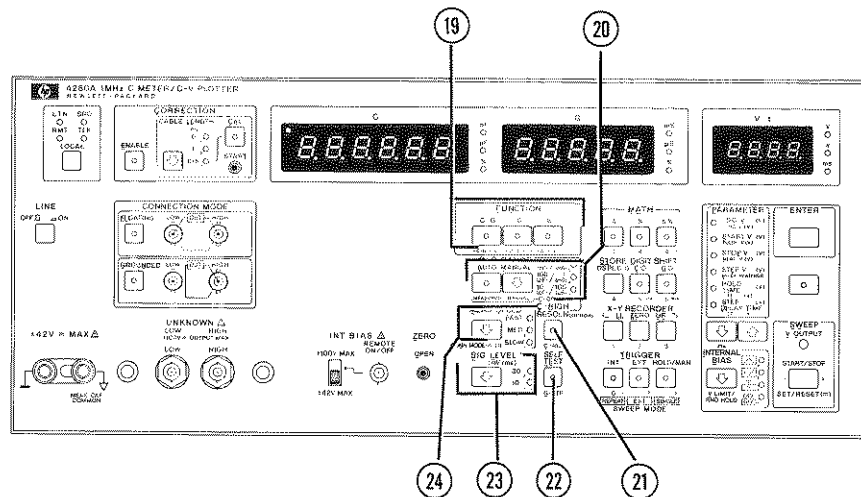

19) FUNCTION Select Keys:

These keys select the measurement function and, when the Blue key (11) is on (key indicator lamp is lit), change the measurement mode from C mode (non-sweep) or C-V mode (bias sweep) to C-t mode (time sweep) and back again. When the instrument is in C mode or C-V mode, the indicator lamp on the selected function key lights continuously, and the functions labelled in black (C-G, C, and G) are valid. When the instrument is in C-t mode, the indicator lamp on the selected function key flashes off and on, and the functions labelled in grey (C-G-t, C-t, and G-t) are valid.

C-G, C, G:

When C-G is selected, the 4280A measures both capacitance, C, and equivalent parallel conductance, G. When C or G is selected, only capacitance or only conductance, respectively, is measured. The 4280A is in C mode when INTERNAL BIAS (13) is set to \equiv or OFF; it is in C-V mode when INTERNAL BIAS is set to \square or \square .

C-G-t, C-t, G-t:

These functions are available only when the 4280A is in C-t mode (time sweep). To set the instrument to C-t mode, press the Blue key (11) (key indicator lamp should come on), and then press the desired FUNCTION key. The indicator lamp at the center of the key will begin to flash. The other two functions can now be selected directly, without the Blue key. To change back to C mode or C-V mode, press the Blue key again, and then press the function key whose indicator lamp is flashing.

Figure 3-2. Front Panel Features (Sheet 7 of 12)

②① C-G RANGE Keys and Indicators:

These keys select the ranging mode—AUTO or MANUAL—and the measurement range. The three adjacent indicator lamps show the selected measurement range.

AUTO:

When the indicator lamp at the center of this key is on, the 4280A is in AUTO ranging mode and will automatically select the measurement range that best suits the value of the device under test.

MANUAL:

When this key is pressed, the AUTO key indicator lamp will go off and the measurement range will be fixed at the selected range. To change measurement range, press this key. To return to AUTO ranging mode, press the AUTO key.

②② C-HIGH RESOLN Key (Option 001 Only):

This key enables high resolution capacitance measurements. It is used in conjunction with the CORRECTION ENABLE key ④ and the C-OFFSET keys ③②. Refer to paragraph 3-161 for details.

②③ SELF TEST Key:

This key initiates the instrument's SELF TEST function. During SELF TEST (key indicator lamp is on), eight tests that check the basic operation of the instrument are automatically performed. Nothing must be connected to the UNKNOWN terminals ②⑦ during the test. SELF TEST is repeated until this key is pressed again. If an abnormality is detected, an error code will be displayed on the C display ⑥. SELF TEST error codes are described in paragraph 3-7. When SELF TEST is canceled, the instrument is set to its initial control settings. If this key is pressed unintentionally, control settings can be maintained by quickly pressing this key again, while *S E L F* is displayed on the C and G displays. Refer to paragraph 3-7 for complete details on SELF TEST.

②④ SIG LEVEL Select Key and Indicators:

This key selects the test signal level—30mVrms or 10mVrms. The adjacent indicator lamps show the selected test signal level.

②⑤ MEAS SPEED Select Key and Indicators:

This key selects the measurement speed—FAST, MED, and SLOW. Actual measurement speed depends on the control settings and the value of the device under test. The adjacent indicator lamps show the selected measurement speed.

Figure 3-2. Front Panel Features (Sheet 8 of 12)

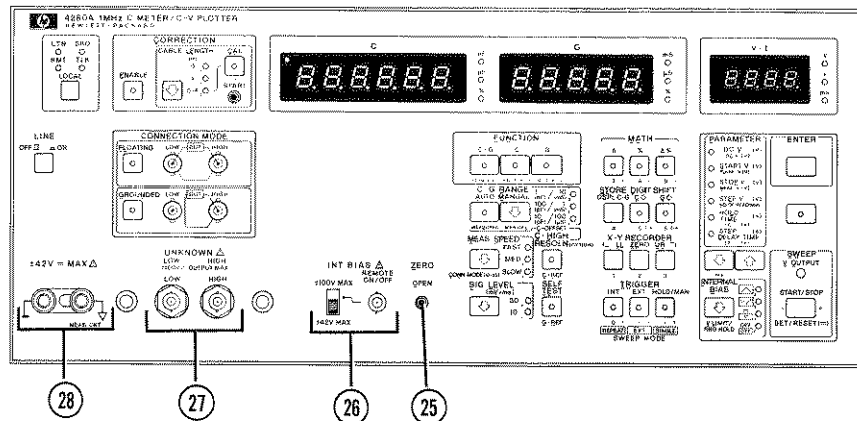

25 ZERO OPEN Button:

This button is for ZERO offset compensation of the stray capacitance and conductance inherent in the test fixture, test leads, and measurement circuit. When this key is pressed, the test fixture or test leads must be terminated open (nothing connected).

26 INT BIAS Δ :

This slide switch and BNC connector are safety features that, respectively, limit and shut down the output from the internal dc bias source.

REMOTE ON/OFF:

This connector is used for remote on/off control of the internal dc bias source when the adjacent slide switch is set to the $\pm 100V$ MAX position. When the center conductor of this connector is grounded (mechanically or electrically), the internal dc bias source outputs the specified voltage. When the center conductor is left open or when a TTL level HIGH is applied to it, output from the internal dc bias source is shut down.

Δ CAUTION

DO NOT APPLY AN EXTERNAL DC BIAS VOLTAGE TO THIS CONNECTOR.

WARNING

DO NOT USE THE FURNISHED BNC SHORTING CAP FOR GROUNDING THE REMOTE ON/OFF CONNECTOR.

Limit Switch:

This switch limits the output voltage from the internal dc bias source. It also functions as a mechanical stop when set to the $\pm 100V$ MAX position, preventing connection of test fixtures designed for low voltage measurements.

$\pm 100V$ MAX.:

Maximum output ($\pm 100V$) from the internal dc bias source is possible. Connection of HP test fixtures designed for use at $\pm 42V$ and below is made physically impossible. The center conductor of the REMOTE ON/OFF connector must be grounded to enable output from the internal dc bias source.

$\pm 42V$ MAX.:

Output from the internal dc bias source is limited to ± 42 volts to ensure operator safety.

Figure 3-2. Front Panel Features (Sheet 9 of 12)

②⑦ UNKNOWN Terminals ⚠:

These two BNC connectors are the 4280A's measurement terminals. They have a two-terminal pair configuration: HIGH terminal and LOW terminal. Two-terminal pair test fixtures, such as the furnished 16080A, connect directly to these terminals.

⚠ WARNING

WHEN BIAS VOLTAGE IS USED
DANGEROUS VOLTAGE (MAXIMUM
±100V) MAY APPEAR ON THESE
TERMINALS.

②⑧ Ground(⊥)-MEAS CKT COMMON (∇) Terminals ⚠:

The ground terminal (⊥) is tied directly to the instrument's chassis and to the earth terminal (offset pin) of the ~ LINE input receptacle (⑩ in Figure 3-3) on the rear panel. The MEAS CKT COMMON (∇) terminal is tied directly to the common of the instrument's measurement circuit and to the outer shields of the UNKNOWN terminals ②⑦. These terminals can be interconnected with the attached shorting strap.

⚠ WARNING

THE GROUND-REFERENCED POTENTIAL ON THE EXPOSED OUTER SHIELDS OF THE UNKNOWN TERMINALS AND ON THE MEAS CKT COMMON TERMINAL (∇) CAN BECOME DANGEROUSLY HIGH WHEN THE GROUND (⊥) AND MEAS CKT COMMON TERMINALS ARE NOT INTERCONNECTED.

Figure 3-2. Front Panel Features (Sheet 10 of 12)

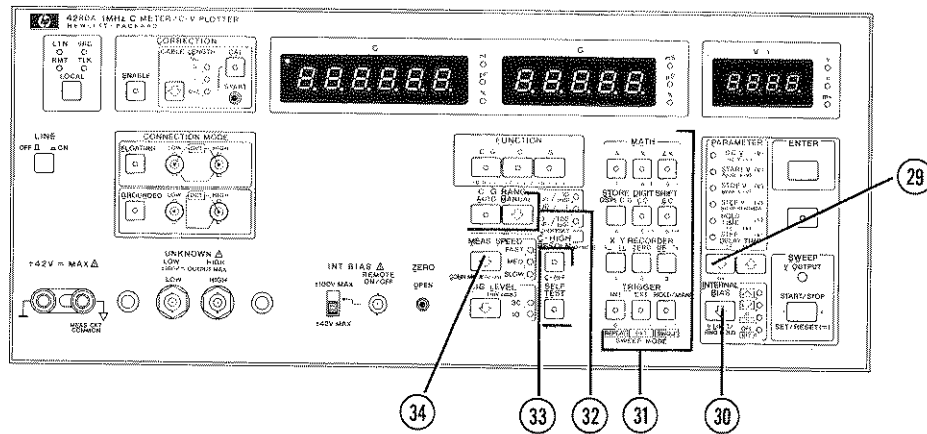

Blue shift Functions

The following functions are labeled in blue on the front panel. They are available when the Blue key (11) is on (when the key indicator lamp is lit).

(29) ms (millisecond) Key:

This key is used when entering time parameters. Pressing this key after a time value has been keyed in with the numeric keys (31) changes the time unit from seconds to milliseconds. The ms unit indicator lamp on the V-t display (8) will light.

(30) V LIMIT/RNG HOLD Key:

This key is used to set the maximum allowable output from the internal dc bias source during non-sweep constant bias measurements (C mode). It also sets the range (and therefore the resolution) of the output voltage. To set the output voltage limit, press the Blue key, press the V LIMIT/RNG HOLD key (the previously set limit or *AUTO* will appear on the V-t display (8)), key in the desired limit with the numeric keys (31), and then press ENTER (10). Refer to paragraph 3-62 for details.

(31) Numeric Keys:

These keys—0 through 9, decimal point and minus sign—are used for entering parameter values, MATH function reference values, and other numeric data. Press ENTER (10) to validate numeric data that has been keyed in.

(32) C-OFFSET Keys (Option 001 only):

These keys are used with the C-HIGH RESOLN key (21) to enter capacitance offset values. Refer to paragraph 3-161 for details.

MEASURED:

Pressing this key and then the ENTER key (10) when the C-HIGH RESOLN key (21) is on (key indicator lamp is lit) sets the measured capacitance value as the offset value.

MANUAL:

This key is used to manually set the capacitance offset value with the numeric key (31) and ENTER key (10).

Figure 3-2. Front Panel Features (Sheet 11 of 12)

33 C-REF/G-REF Keys:

These keys are used to store reference values for the MATH functions 14 and to recall (display) previously stored reference values.

C-REF: Pressing this key while the Blue key 11 is on displays the stored reference values for capacitance and conductance on the C display 6 and G display 7, respectively. Also, rEF is displayed on the V·t display 8. A capacitance reference value can be entered with the numeric keys 31 and the ENTER key 11.

G-REF:

This key is for entering conductance reference values. It functions in the same manner as the C-REF key.

34 CONN MODE Key:

This key is used to select the connection mode with the numeric keys 31 and ENTER key 11. Refer to paragraph 3-31 for details.

Figure 3-2. Front Panel Features (Sheet 12 of 12)

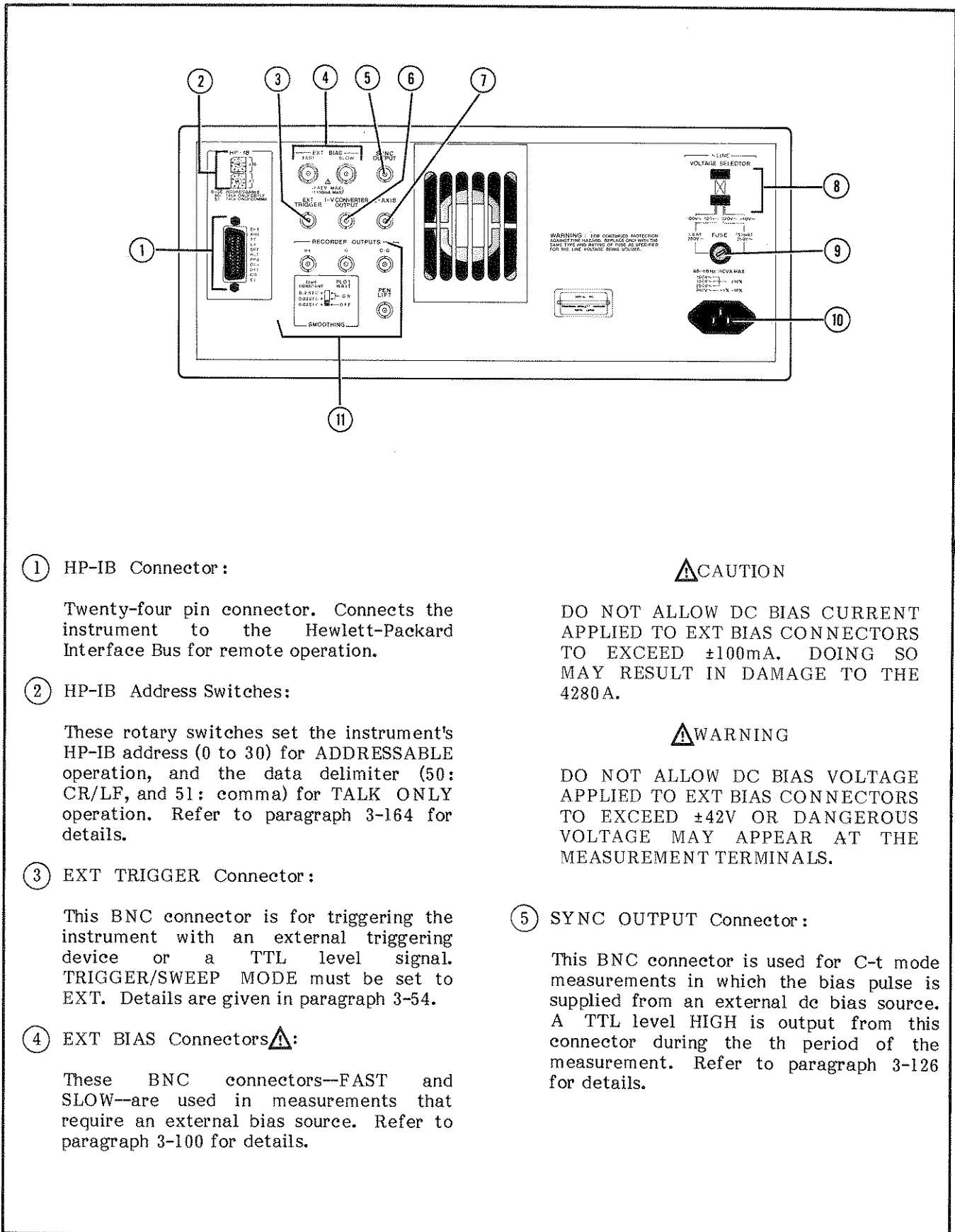

① HP-IB Connector:

Twenty-four pin connector. Connects the instrument to the Hewlett-Packard Interface Bus for remote operation.

② HP-IB Address Switches:

These rotary switches set the instrument's HP-IB address (0 to 30) for ADDRESSABLE operation, and the data delimiter (50: CR/LF, and 51: comma) for TALK ONLY operation. Refer to paragraph 3-164 for details.

③ EXT TRIGGER Connector:

This BNC connector is for triggering the instrument with an external triggering device or a TTL level signal. TRIGGER/SWEEP MODE must be set to EXT. Details are given in paragraph 3-54.

④ EXT BIAS Connectors ⚠:

These BNC connectors—FAST and SLOW—are used in measurements that require an external bias source. Refer to paragraph 3-100 for details.

⚠ CAUTION

DO NOT ALLOW DC BIAS CURRENT APPLIED TO EXT BIAS CONNECTORS TO EXCEED $\pm 100\text{mA}$. DOING SO MAY RESULT IN DAMAGE TO THE 4280A.

⚠ WARNING

DO NOT ALLOW DC BIAS VOLTAGE APPLIED TO EXT BIAS CONNECTORS TO EXCEED $\pm 42\text{V}$ OR DANGEROUS VOLTAGE MAY APPEAR AT THE MEASUREMENT TERMINALS.

⑤ SYNC OUTPUT Connector:

This BNC connector is used for C-t mode measurements in which the bias pulse is supplied from an external dc bias source. A TTL level HIGH is output from this connector during the th period of the measurement. Refer to paragraph 3-126 for details.

Figure 3-3. Rear Panel Features (Sheet 1 of 2)

⑥ I-V CONVERTER OUTPUT Connector:

This BNC connector is for monitoring, with an oscilloscope, the waveform of the 4280A's analog measurement circuit.

⑦ Z-AXIS Connector:

This BNC connector outputs a TTL level signal which can be used to control the intensity of an oscilloscope during the sampling period of C-t mode (sampling mode) measurements.

⑧ ~ LINE VOLTAGE SELECTOR Switches:

These switches set the instrument's line voltage. Refer to paragraph 2-8.

⑨ ~ LINE FUSE Holder:

The main power-line fuse is installed in this holder. Refer to paragraph 2-8.

⑩ ~ LINE Input Receptacle:

The power cord connects to this receptacle. Refer to paragraph 2-10.

⑪ RECORDER OUTPUTS:

These connectors and this slide switch are for plotting the characteristics of the device under test on an X-Y recorder. Refer to paragraph 3-156 for a complete explanation.

Figure 3-3. Rear Panel Features (Sheet 2 of 2)

3-7. SELF TEST

3-8. The self test function checks most of the instrument's basic capabilities and, when service is required, assists the service technician in troubleshooting. There are two different self tests: (1) Power On Self Test, which is automatically performed each time the instrument is turned on, and (2) Standard Self Test, which the operator can execute at any time by pressing the SELF TEST key on the front panel or by sending program code "TE1" via the HP-IB.

[Power On Self Test]

Each time the 4280A is turned on, the microprocessor starts the Power On Self Test. Table 3-1 lists the contents of the Power On Self Test, provides a brief description of each self test element, and shows the corresponding error codes. If error code "Err H1" (illegal HP-IB address) appears on the C display after the DISPLAY TEST, turn the 4280A off, set the HP-IB address switches to a valid address (0 ~ 30), and turn the 4280A on again. (Refer to paragraph 3-174 for details on how to set the HP-IB address.) If a front panel lamp fails to light during the DISPLAY TEST, or if error code "Err P1, "Err H2," or "Err I1" through "Err I5" is displayed on the C display, contact the nearest Hewlett-Packard service office to arrange for repairs.

Note

"Err H1" and "Err H2" are not fatal errors. The 4280A will, in most cases, operate normally in LOCAL mode, despite these errors. If "Err P1" or "Err I1" through "Err I5" occurs, however, normal operation is impossible.

[Standard Self Test]

The standard Self Test can be executed at any time from the front panel or under remote control via the HP-IB (program code TE1) to confirm normal operation of the 4280A's basic functions. When the operator executes the Standard Self Test, the nine tests listed in Table 3-2 are automatically performed. Self test is repeated until the SELF TEST key is pressed again. If the 4280A fails a test other than the DISPLAY TEST, the corresponding error code will appear on the C display. To perform the self test, connect nothing to the UNKNOWN terminals and then press the SELF TEST key.

SELF will appear on the C and G displays for about two seconds. Following this, all LED lamps and display segments will be lighted for about two seconds. Observe the front panel for any inoperative lamps or display segments. After the DISPLAY TEST, tests 1 through 8 will be sequentially executed. The test number is displayed on the V-t display. After test 8, self test is repeated starting with the DISPLAY TEST. When self test mode is released, the microprocessor initializes all control settings and clears the random-access-memory (RAM) of reference values used for the MATH functions, error correction information, and C offset data (Option 001 only). Initial Control Settings are given in paragraph 3-17. If the SELF TEST key is accidentally pressed, quickly press the key again while SELF is displayed on the C and G displays. This cancels the self test before it starts; thus, preventing instrument initialization. If the instrument fails self test, contact the nearest Hewlett-Packard service office to arrange repairs.

3-9. MEASUREMENT FUNCTIONS AND MEASUREMENT MODES

3-10. The 4280A has three measurement functions--C-G function, C function and G function--and three measurement modes--C mode, C-V mode and C-t mode. Each measurement mode and measurement function is described below.

[Measurement Functions]

C-G function: When this function is selected, the 4280A measures both capacitance, C, and conductance, G. Measured C and G values are displayed on the C display and G display, respectively.

C Function: When this function is selected, the 4280A measures only capacitance, C. Measured C values are displayed on the C display. The G display will be blank. Measurement speed is about double (not specified) that of C-G function measurements.

G function: When this function is selected, the 4280A measures only conductance, G. Measured G values are displayed on the G display. The C display will be blank. Measurement speed is about double (not specified) that of C-G function measurements.

[Measurement Modes]

C Mode: When set to this mode, the 4280A measures the device under test at a constant (nonsweep) dc bias voltage. The measurement parameter (C-G, C, G) is determined by the selected measurement function. The indicator lamp on the selected FUNCTION key will be lit.

C-V Mode: When set to this mode, the 4280A measures the device under test with swept (staircase) dc bias voltage. The measurement parameter (C-G, C, G) is determined by the selected measurement function. The indicator lamp on the selected FUNCTION key will be lit.

C-t Mode: When set to this mode, the 4280A measures the capacitance or conductance of the device under test as a function of time. The measurement parameter (C-G, C, G) is determined by the selected measurement function. The indicator lamp on the selected FUNCTION key will blink off and on.

3-11. Measurement functions are selected from the front panel by pressing the appropriate FUNCTION key--C-G, C or G--or from a remote controller by sending the function's program code via the HP-IB. Program codes are given in paragraph 3-180. In C and C-V measurement modes, the indicator lamp on the selected FUNCTION key will remain lit (will not blink) until another measurement function is selected. In C-t mode, however, the selected FUNCTION key indicator lamp will blink at a rate of about 1Hz. C measurement mode and C-V measurement mode are set by the INTERNAL BIAS key. When $\overline{\text{C}}$ or $\overline{\text{V}}$ is selected, C-V mode is set; when $\overline{\text{C}}$ or OFF is selected, C mode is set. C-t mode is set by first pressing the blue key (indicator lamp lights) and then pressing the desired FUNCTION key. To exit the C-t mode, first press the blue key and then press the FUNCTION key whose indicator lamp is blinking. This will set the 4280A to C mode. Though it is possible to go directly to C-t mode

from C-V mode, it is not possible to do the opposite. Figure 3-4 shows how to change directly from one function/mode combination to another. The table below lists all the possible combinations of functions and modes.

3-12. DISPLAYS

3-13. The 4280A has three front panel displays--the C display, the G display, and the V-t display. These displays provide direct readout of measured values, parameter setting values, and other information intended for the operator. Located to the right of each display are three LED lamps that show the unit of displayed numbers.

3-14. The C display provides direct readout of measured capacitance values, C reference values for MATH operations, self test error codes, overflow annunciations, and the HP-IB address switch setting. When G function (G, G-V or G-t measurement) is selected, the C display is turned off (blanked). Unit indicator lamps light to show nF (nano-farad), pF, (pico-farad) or % (percent) values. Maximum number of display digits, maximum display value, and maximum display resolution depend on control settings. Refer to Figure 3-5.

3-15. The G display provides direct readout of measured conductance values, G reference values for MATH operations, overflow annunciations, and the setting of the SMOOTHING switch on the rear panel. When C function (C, C-V or C-t) is selected, the G display is turned off (blanked). Unit indicator lamps light to show mS (milli-siemens), μS (micro-siemens), or % (percent) values. Maximum number of display digits, maximum display value, and maximum display resolution depend on control settings. Refer to Figure 3-6.

3-16. The V-t display has four digits and provides direct readout of PARAMETER values (voltage and time), operation error codes, connection mode code numbers, and annunciations for special measurements and operations. Unit indicator lamps light to show V (volts), s (seconds), and ms (milliseconds) values.

	C-G FUNCTION	C FUNCTION	G FUNCTION
C MODE	C-G measurement	C measurement	G measurement
C-V MODE	C-G-V measurement	C-V measurement	G-V measurement
C-t MODE	C-G-t measurement	C-t measurement	G-t measurement

Table 3-1. Power On Self Test

TEST	Description	Error Code
DISPLAY TEST	Lights all LED lamps and 7-segment displays on the front panel for about two seconds. (Confirm that all the lamps are lit.)	None
ROM/RAM TEST	Checks the contents of read-only memory (ROM) and verifies correct operation of random access memory (RAM).	Err P1
HP-IB TEST	Verifies correct setting of the HP-IB Address switch.	Err H1
	Verifies correct operation of the HP-IB interface circuit.	Err H2
TIMER TEST	Verifies correct operation of the timer circuit.	Err 11 thru Err 15

Table 3-2. Standard Self Test

TEST	Description	Error Code
0	Lights all LED lamps and 7-segment displays on the front panel for about two seconds. (Confirm that all the lamps are lit.)	None
1	Verifies correct operation of the timer circuit.	Err 11 thru Err 15
2	Verifies correct zero scale output from the vector ratio detector (VRD).	Err 21
3	Verifies correct full scale output from the vector ratio detector (VRD).	Err 31
4	Open Test for connection mode 10.	Err 41
5	Open Test for connection mode 15.	Err 51
6	Open Test for connection mode 18.	Err 61
7	Open Test for connection mode 21.	Err 71
8	Verifies correct operation of the C-OFFSET circuit. (Only on instruments equipped with option 001).	Err 81

The UNKNOWN terminals must be open terminated (nothing connected) during self test.

Present Setting	Desired Setting								
	C - G	C	G	C·G-V	C - V	G - V	C·G-t	C - t	G - t
C - G		b	c	d	N	N	f	g	h
C	a		c	N	d	N	f	g	h
G	a	b		N	N	d	f	g	h
C·G-V	e	N	N		b	c	f	g	h
C - V	N	e	N	a		c	f	g	h
G - V	N	N	e	a	b		f	g	h
C·G-t	f	N	N	N	N	N		b,(g)	c,(h)
C - t	N	g	N	N	N	N	a,(f)		c,(h)
G - t	N	N	h	N	N	N	a,(f)	b,(g)	

- a : Press the C-G FUNCTION key.
- b: Press the C FUNCTION key
- c: Press the G FUNCTION key.
- d: Select INTERNAL BIAS \uparrow or \downarrow .
- e: Select INTERNAL BIAS \equiv or OFF.
- f: Press the blue key and the C-G FUNCTION key.
- g: Press the blue key and the C FUNCTION key
- h: Press the blue key and the G FUNCTION key.
- N: Cannot be selected directly.

Figure 3-4. Interchanging Measurement Functions and Measurement Modes

Maximum number of display digits, maximum display value, and maximum display resolution of the C display depend on measurement speed, signal level, measurement range, and error correction. Refer to the following tables.

CORRECTION function turned off (ENABLE key indicator lamp not lit):

MEAS SPEED		SLOW		MED		FAST	
SIG LEVEL		30	10	30	10	30	10
C.G RANGE	1nF	- 19000	to 19000	- 1900	to 1900	- 1900	to 1900
	100pF	- 19000	to 19000	- 1900	to 1900	- 1900	to 1900
	10pF	- 19000	to 19000	- 1900	to 1900	- 1900	to 1900

CORRECTION function turned on (ENABLE key indicator lamp lit):

MEAS SPEED		SLOW		MED		FAST	
SIG LEVEL		30	10	30	10	30	10
C.G RANGE	1nF	+90000	to 190000	- 19000	to 19000	- 19000	to 19000
	100pF	+90000	to 190000	- 19000	to 19000	- 19000	to 19000
	10pF	+90000	to 190000	- 19000	to 19000	- 19000	to 19000

% or Δ % measurement:

* C-HIGH RESOLN	SLOW		MED		FAST	
	30	10	30	10	30	10
OFF	- 19000	to 19000	- 1900	to 1900	- 1900	to 1900
ON	+90000	to 190000	- 19000	to 19000	- 19000	to 19000

*Option 001, C High Resolution. Refer to paragraph 3-161.

Figure 3-5. Maximum Display Value, Display Digits, and Resolution for the C Display

Maximum number of display digits, maximum display value, and maximum display resolution of the G display depend of measurement speed, signal level, measurement range, and error correction. Refer to the following tables.

CORRECTION function turned off (ENABLE key indicator lamp not lit):

MEAS SPEED		SLOW		MED		FAST	
SIG LEVEL		30	10	30	10	30	10
C.G RANGE	10mS	-12000	to 12000	-1200	to 1200	-1200	to 1200
	1mS	-12000	to 12000	-1200	to 1200	-1200	to 1200
	100µS	-12000	to 12000	-1200	to 1200	-1200	to 1200

CORRECTION function turned on (ENABLE key indicator lamp lit):

MEAS SPEED		SLOW		MED		FAST	
SIG LEVEL		30	10	30	10	30	10
C.G RANGE	10mS	-19000	to 19000	-1900	to 1900	-1900	to 1900
	1mS	-19000	to 19000	-1900	to 1900	-1900	to 1900
	100µS	-19000	to 19000	-1900	to 1900	-1900	to 1900

% or Δ % measurement:

SLOW		MED		FAST	
30	10	30	10	30	10
-12000	to 12000	-1200	to 1200	-1200	to 1200

Figure 3-6. Maximum Display Value, Display Digits, and Resolution for the G Display

3-17. INITIAL DISPLAY AND CONTROL SETTINGS

3-18. Each time the 4280A is turned on, the Power On self Test is automatically executed. If no fatal errors are detected, the HP-IB address and the PLOT WAIT setting will appear briefly on the C display and G display, respectively, as shown below.

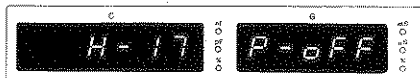

The above example shows the factory set HP-IB address (17) and PLOT WAIT setting (off). While the HP-IB address and PLOT WAIT setting are displayed, all front panel LED lamps (except certain digit segments on the C and G displays) will be lit. Measurement will begin automatically. For more information concerning PLOT WAIT and the HP-IB address, refer to paragraphs 3-156 and 3-174, respectively.

3-19. Initial control settings are established each time the 4280A is turned on and after self test is performed. Initial control settings are listed below.

FUNCTION	C-G
CONNECTION MODE	FLOATING, CN10
INTERNAL BIAS	==
C-G RANGE	AUTO
MEAS SPEED	MED
SIG LEVEL	30mVrms
TRIGGER	INT
V OUTPUT	RESET (==)
V LIMIT/RNG HOLD	Auto
CABLE LENGTH	0m
CORRECTION ENABLE	ON
ZERO OPEN DATA	0pF/0 μ S
DIGIT SHIFT C	OFF
DIGIT SHIFT G	OFF
MATH	OFF
C-REF	0pF
G-REF	0 μ S
SELF TEST	OFF

For units equipped with option 001:

C-HIGH RESOLN	OFF
C-OFFSET DATA	0pF/0 μ S

3-20. The initial settings of all PARAMETERS are listed below.

C mode

DC V (V) 0V

C-V mode

START V (V) 0V
 STOP V (V) 0V
 STEP V (V) 0V
 HOLD TIME (s) 3ms
 STEP DELAY TIME (s) ... 3ms

C-t mode

DC V (V) 0V
 PULSE V (V) 0V
 MEAS V (V) 0V
 NO OF READINGS 100
 th (s) 10ms
 td (s) 250ms

3-21. ERROR CODES

3-22. Three types of error codes are displayed on the front panel: (1) self test error codes, which are displayed on the C display; (2) overflow annunciations, which appear on both the C display and G display; and (3) operation error codes, which appear on the V-t display. Tables 3-1 and 3-2 list the self test error codes and provide a brief description of each. Refer to paragraph 3-7 for details. Table 3-3 lists the overflow annunciations, describes the meaning of each annunciation, and provides one or two possible remedies. Table 3-4 lists all the operation error codes and explains the cause of each. Many of the error codes listed in Table 3-4 will not be displayed on the V-t display, if they occur. These HP-IB-related errors can be read only by a controller (computer) via the HP-IB in LEARN mode. Refer to paragraph 3-219 for instructions on LEARN mode operation. Error codes common to both HP-IB and manual (front panel keys) operations will be displayed on the V-t display. These are indicated by an H and M in the right most column of Table 3-4. Also, in Table 3-4, n and v following certain remote program codes indicate an integer and a decimal number, respectively.

Table 3-3. Overflow Annunciations

Annunciation	Meaning	Remedy
OF-01 through OF-07	The analog measurement circuits are saturated. Refer to Table 8-8.	Select a higher C·G range.
OF-08	The result of a MATH calculation is too large to display.	Select a higher C·G range or change the MATH function reference value.
OF-01 through OF-07 appear on both the C display and G display, regardless of which display caused the overflow. OF-08, however, appears only on the display causing the overflow.		

Table 3-4. Operation Error Codes (Sheet 1 of 7)

Error-Code	Meaning	Operation
E - 1.0	An illegal program code was sent while the 4280A was set to isolation mode (see paragraph 3-214). ISO, IS1, ID?, MF?, CF?, SET? and ERR? are the only program codes permitted in isolation mode.	H
E - 1.1	An illegal program code was sent during self test (TE1). TE0, TE1, and ERR? are the only program codes permitted during self test. Sending program code TE1 restarts the self test.	H
E - 1.2	A program code was sent during a ZERO OPEN, CABLE LENGTH CAL, or C-OFFSET measurement. No program codes may be sent during these measurements.	H
E - 1.3	An illegal program code was sent during a swept measurement (C-V or C-t mode). SW0 and SW1 are the only program codes permitted during a swept measurement. SW1 is ignored if sent during a sweep.	H
E - 1.4	An illegal program code was sent while the 4280A was set to connection mode CN21, CN22, or CN23. CNn, TRn, EX ID?, MF?, CF?, SET? and ERR? are the only program codes permitted.	H
E - 1.5	Program code SW1 (sweep start) was sent while the 4280A was in C mode. Or program code EX was sent while the 4280A was in C-V or C-t mode.	H

Table 3-4. Operation Error Codes (Sheet 2 of 7)

Error-Code	Meaning	Operation
E - 2.0	The CORRECTION ENABLE key was pressed or program code CE1 was sent, but error correction cannot be done because the ZERO OPEN offset value is too large or CABLE LENGTH CAL has been performed but ZERO OPEN has not.	H, M
E - 2.1	The CORRECTION ENABLE key was pressed or program code CE1 was sent, but error correction cannot be done because CABLE LENGTH CAL offset value is too large.	H, M
E - 2.2	The ZERO OPEN button was pressed or program ZO was sent while CABLE LENGTH was set to 0-5(m), but CABLE LENGTH CAL offset value is too large.	H, M
E - 2.3	Program code CA was sent while CABLE LENGTH was set to 0(m) or 1(m).	H
E - 3.0	An illegal number was entered for connection mode. CN10 through CN23 are the only valid connection modes.	H, M
E - 3.1	Connection mode CN13 or CN14 was set while the 4280A was set to C-V mode. CN13 and CN14 are possible in C mode and C-t mode only.	H, M
E - 4.0	The C-REF value specified in program code CR is too large. Maximum allowable value is $\pm 199999E-12$.	H
E - 4.1	The G-REF value specified in program code GR is too large. Maximum allowable value is $\pm 19999E-6$.	H
E - 4.2	The STORE DISPL C·G key was pressed or program code ST was sent while OF-n, -----, or a percent was on the C display or G display.	H, M
E - 4.3	The STORE DISPL C·G key was pressed or program code ST was sent while a MATH function was set.	H, M

Table 3-4. Operation Error Codes (Sheet 3 of 7)

Error-Code	Meaning	Operation
E - 5.0	One of the option 001-related operations listed below was attempted, but option 001 is not installed. (1) C-HIGH RESOLN key was pressed. (2) C offset value was entered with the C-OFFSET MEASURED key or C-OFFSET MANUAL key. (3) Program code CH1, CS, or CLv was sent.	H, M
E - 5.1	While the C-HIGH RESOLN function was turned off (C-HIGH RESOLN key indicator lamp not lit), an attempt was made to enter a C offset value with the C-OFFSET MEASURED key and ENTER key or by sending program code CS.	H, M
E - 5.2	While the C-HIGH RESOLN function was turned off (C-HIGH RESOLN key indicator lamp not lit), an attempt was made to enter a C offset value with the C-OFFSET MANUAL key, numeric keys, and ENTER key or by sending program code CLv.	H, M
E - 5.3	The C offset value entered with the C-OFFSET manual key, numeric keys, and ENTER key exceeds 1024. Or the C offset value specified by program code CLv is either negative or is greater than 1023.5E-12.	H, M
E - 6.0	Program code IB2 or IB3 was sent while the 4280A was in C mode and connection mode CN13 or CN14 was set.	H
E - 6.1	Program code IB1 was sent while the 4280A was set to connection mode CN14. Or program code IB2 was sent while the 4280A was in C-t mode and connection mode CN13 or CN14 was set.	H
E - 6.2	Program code IB3 was sent while the 4280A was in C-t mode. Or program code IB0 or IB1 was sent while the 4280A was in C-t mode and connection mode CN10, CN15 or CN18 was set.	H
E - 6.3	The DC V value (C mode) entered exceeds the limit set by the INT BIAS switch ($\pm 42V$ or $\pm 100V$).	H, M
E - 6.4	An illegal value was entered for V LIMIT (C mode). Values from 0 to 100 can be entered from the front panel, and values from -100 to 100 can be entered via the HP-IB. However, any negative value (up to -100) sent is interpreted as 0, thereby setting RNG HOLD to AUTO.	H, M
E - 6.5	Program code VLv was sent while the 4280A was in C-V or C-t mode.	H
E - 6.6	Program code MS3 was sent while the 4280A was in C-t mode.	H

Table 3-4. Operation Error Codes (Sheet 4 of 7)

Error-Code	Meaning	Operation
E - 7.0	In C mode, the SWEEP/V OUTPUT key was pressed or program code VO1 was sent while the INT BIAS limit switch was set to $\pm 100V$ MAX and the REMOTE ON/OFF connector was open terminated (center conductor was HIGH), or while the INT BIAS limit switch was set to $\pm 42V$ and the DC V value was higher than $\pm 42V$.	H, M
E - 7.1	In C mode, the REMOTE ON/OFF connector was open terminated (center conductor was brought HIGH) while the INT BIAS limit switch was set to $\pm 100V$ MAX and V OUTPUT lamp was lit. Or, in C mode, the setting of the INT BIAS limit switch was changed from $\pm 100V$ MAX to $\pm 42V$ MAX while the V OUTPUT lamp was lit and DC V was higher than $\pm 42V$.	M
E - 7.2	In C-V mode or C-t mode, the SWEEP/V OUTPUT key was pressed or program code SW1 was sent while (1) the INT BIAS limit switch was set to $\pm 100V$ MAX and the REMOTE ON/OFF connector was open terminated (center conductor was HIGH), or (2) the INT BIAS limit switch was set to $\pm 42V$ MAX, and START V or STOP V (C-V mode), or PULSE V, MEAS V or DC V (C-t mode) value was higher than $\pm 42V$.	H, M
E - 7.3	In C-V mode or C-t mode, the REMOTE ON/OFF connector was open terminated (center conductor was brought HIGH) while the INT BIAS limit switch was set to $\pm 100V$ MAX and a measurement was in progress (V OUTPUT lamp lit). Or, in C-V mode or C-t mode, the setting of the INT BIAS limit switch was changed from $\pm 100V$ MAX to $\pm 42V$ MAX during a measurement (V OUTPUT lamp lit) in which the START V or STOP V (C-V mode), or the PULSE V, MEAS V or DC V (C-t mode) value was higher than $\pm 42V$.	M
E - 8.0	The START V value exceeds the limit set by the INT BIAS limit switch ($\pm 42V$ or $\pm 100V$).	H, M
E - 8.1	The STOP V value exceeds the limit set by the INT BIAS limit switch ($\pm 42V$ or $\pm 100V$).	H, M
E - 8.2	Illegal STEP V value. Permissible range is 0 to +200.	H, M
E - 8.3	Illegal HOLD TIME value. Permissible range is 3ms to 650s.	H, M
E - 8.4	Illegal STEP DELAY TIME value. Permissible range is 3ms to 650s.	H, M

Table 3-4. Operation Error Codes (Sheet 5 of 7)

Error-Code	Meaning	Operation
E - 9.0	The DC V value in C-t mode exceeds the limit set by the INT BIAS limit switch ($\pm 42V$ or $\pm 100V$).	H, M
E - 9.1	The PULSE V value exceeds the limit set by the INT BIAS limit switch ($\pm 42V$ or $\pm 100V$).	H, M
E - 9.2	MEAS V value exceeds the limit set by the INT BIAS limit switch ($\pm 42V$ or $\pm 100V$).	H, M
E - 9.3	Illegal th value. Permissible range is 10 μ s to 32s.	H, M
E - 9.4	Illegal td value. Permissible range is 10 μ s to 32s.	H, M
E - 9.5	Illegal NO OF READINGS value. Permissible range is 0 to 9999.	H, M
E - 10.0	Program code BA, BB, BD or BS? was sent while the 4280A was in standard data transfer mode.	H
E - 10.1	Program code BA, BB, BD or BS? was sent while the 4280A was in block data transfer mode, but there was no data ready for transfer.	H
E - 10.2	Program code BL1 was sent while the 4280A was in C mode.	H
E - 10.3	Program code IB0 or IB1 was sent while the 4280A was in C-V mode and block data transfer mode.	H
E - 10.4	Program code CN21, CN22, CN23, Z0, CA, CS, CLv or TE1 was sent while the 4280A was in block data transfer mode.	H
E - 10.5	Program code FN1, FN2 or FN3 was sent while the 4280A was in C-t mode and block data transfer mode.	H

Table 3-4. Operation Error Codes (Sheet 6 of 7)

Error-Code	Meaning	Operation
E - 11.0	The SWEEP/V OUTPUT key was pressed or program code SW1 was sent while the 4280A was in sampling C-t mode and the product of td (in seconds) and the NO OF READINGS was more than 5.	H, M
E - 11.1	The SWEEP/V OUTPUT key was pressed or program code SW1 was sent while the 4280A was in burst C-t mode (program code SA0 was sent, or internal pulsed bias was used), but td was inappropriate for burst mode.	H, M
E - 11.2	During measurement in burst C-t mode, processing time for data transfer, key interrupt, or range change was too long. To shorten processing time, use block data transfer mode, MANUAL ranging, etc.	H, M
E - 11.3	The SWEEP/V OUTPUT key was pressed or program code SW1 was sent while the 4280A was in sampling C-t mode (program code SA1), but the td value was inappropriate for sampling mode.	H, M
E - 11.4	The SWEEP/V OUTPUT key was pressed or program code SW1 was sent while the 4280A was in C-t mode (external bias set to SLOW, C-t measurement) and td was less than 200 μ s.	H, M
E - 11.5	The SWEEP/V OUTPUT key was pressed or program code SW1 was sent while the 4280A was in C-t mode (internal bias, C-t measurement) and th was less than 10ms.	H, M
E - 11.6	The SWEEP/V OUTPUT key was pressed or program code SW1 was sent while the 4280A was in C-t mode (external bias set to SLOW, C-t measurement, burst mode) and th was less than 50 μ s.	H, M
E - 11.7	The SWEEP/V OUTPUT key was pressed or program code SW1 was sent while the 4280A was in C-t mode (external bias set to SLOW, C-t measurement, sampling mode) and th was less than 50 μ s or more than 5s.	H, M
E - 11.8	The SWEEP/V OUTPUT key was pressed or program code SW1 was sent while the 4280A was in C-t mode (external bias set to FAST, C-t measurement, sampling mode) and th was more than 5s.	H, M

Table 3-4. Operation Error Codes (Sheet 7 of 7)

Error-Code	Meaning	Operation
E - 12.0	The SWEEP/V OUTPUT key was pressed or program code SW1 was sent while the 4280A was set to C·G-t measurement (sampling mode), MEAS SPEED was set to FAST, and the th/td ratio exceeded 500.	H, M
E - 12.1	The SWEEP/V OUTPUT key was pressed or program code SW1 was sent while the 4280A was set to C·G-t measurement (sampling mode), MEAS SPEED was set to MED, and the th/td ratio exceeded 100.	H, M
E - 12.2	The SWEEP/V OUTPUT key was pressed or program code SW1 was sent while the 4280A was set to C-t measurement or G-t measurement (sampling mode), MEAS SPEED was set to MED, and the th/td ratio exceeded 200.	H, M

3-23. TEST SIGNAL

3-24. The built-in signal source applies a 1MHz sine wave to the device under test. Frequency accuracy is $\pm 0.01\%$.

3-25. Test signal level is selectable--10mVrms or 30mVrms. Accuracy is $\pm 10\%$ for both levels, and is specified at the UNKNOWN terminals with nothing connected. The actual signal level across the device under test depends on the impedance of the test leads and test fixture used in the measurement, and on the impedance of the device being measured.

3-26. MEASUREMENT SPEED

3-27. The 4280A has three measurement speeds: SLOW, MED and FAST. Measurement time for each speed depends upon the instrument's control settings and the capacitance and conductance of the device under test. Refer to Table 1-2, Supplemental Performance Characteristics.

3-28. When FAST is selected, or when MED is selected and SIG LEVEL is set to 10mV, the number of display digits is one less than is otherwise possible. Select FAST when measurement speed rather than resolution is the primary consideration. When set to SLOW measurement speed, the 4280A averages the results of ten MED speed measurements, thereby reducing display fluctuations.

3-29. MEASUREMENT RANGES

3-30. There are three measurement ranges--1nF/10mS, 100pF/1mS and 10pF/100 μ S--and two ranging modes--AUTO and MANUAL. Each range allows 90% overranging for capacitance and 20% overranging for conductance. Each range provides 10000 counts full scale. Maximum number of counts is 19000 on all C ranges and 12000 on all G ranges. Ranging is controlled by the C-G RANGE keys--AUTO and MANUAL. When AUTO is selected, the 4280A automatically selects the range that best suits the value of the device being measured. Figure 3-7 shows the flow diagram of the 4280A's AUTO ranging routine. When the measurement range is set with the MANUAL key, range is fixed, regardless of the capacitance or conductance of the device under test. If the measured value is too large for the selected range, one of the overflow annunciations listed in Table 3-3 will appear on the C display, G display, or both.

Note

The 10pF/100 μ S range cannot be used for connection modes CN15 through CN20.

Note

Only the highest measurement range is available when connection mode CN21, CN22 or CN23 is selected.

3-31. CONNECTION MODE

3-32. The 4280A has fourteen different connection modes--CN10 through CN23--that make it possible to change the interconnections of the test signal source, ammeter, internal dc bias source, external bias source/pulse generator (if used), and the UNKNOWN terminals. Figure 3-8 shows the equivalent circuit of each connection mode. Connection modes CN10 through CN20 are used for C and G measurements in C mode, C-V mode and C-t mode (refer to paragraph 3-9). The remaining connection modes--CN21, CN22 and CN23--however, are used for measuring inductance and resistance for measurement error correction using a controller. Refer to paragraph 3-56. More information on connection modes is given in paragraphs 3-100, 3-143, and 3-216. The procedure for selecting a connection mode is as follows:

1. Press the blue key.
2. Press the CONN MODE (10--23) key. The existing connection mode will appear on the V-t display.
3. Key in the connection mode number with the numeric keys. The number appearing on the V-t display will change to the new number.
4. Press the ENTER key. You may, depending on which connection modes are involved, hear the connection mode relays operate. The connection mode number will remain on the V-t display until a PARAMETER--bias voltage, for example--is entered.

Note

Connection modes CN10 and CN15 can be selected with the above procedure, or they can be selected by pressing the FLOATING CONNECTION MODE key or the GROUNDED CONNECTION MODE key, respectively.

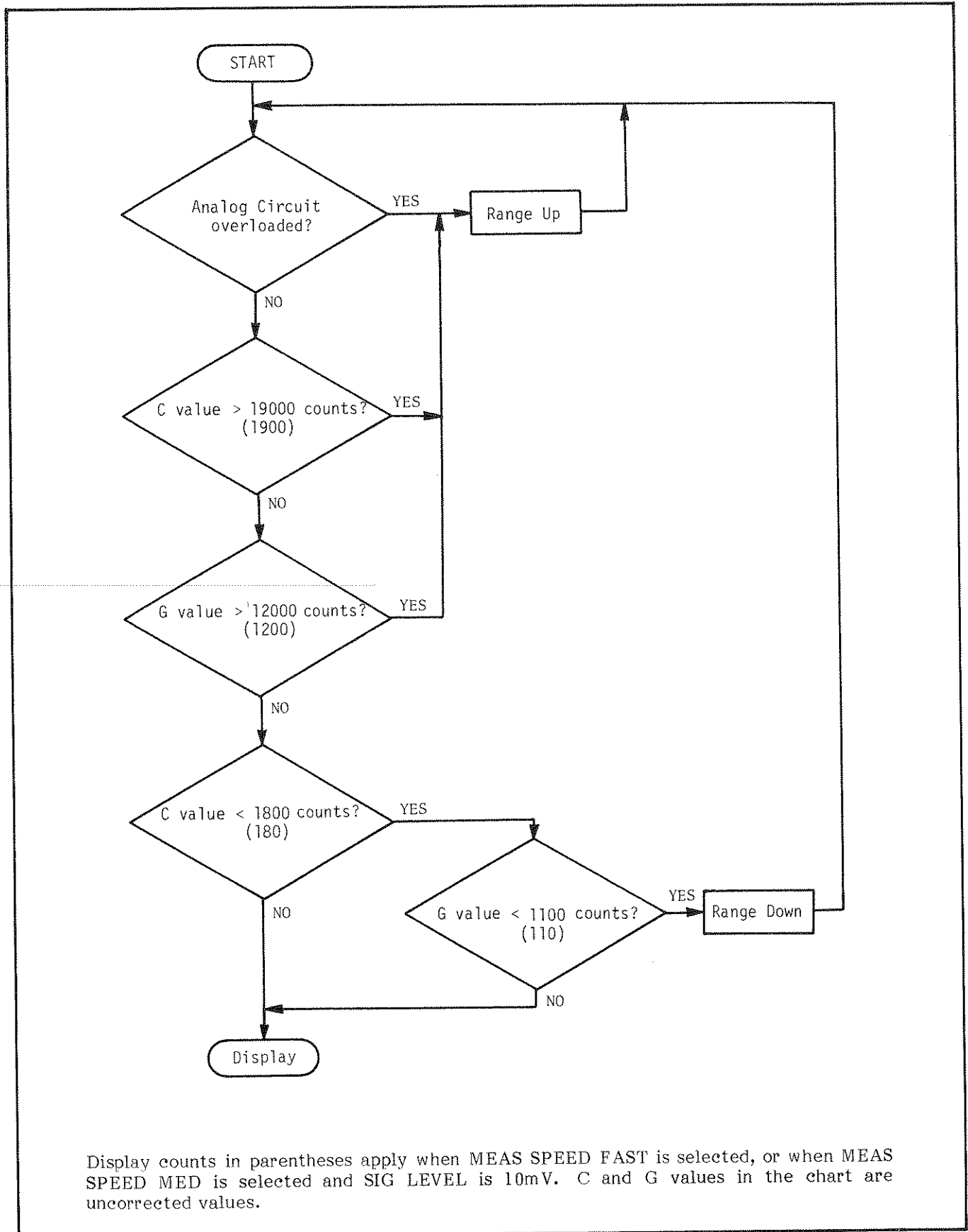

Figure 3-7. AUTO Ranging Operation

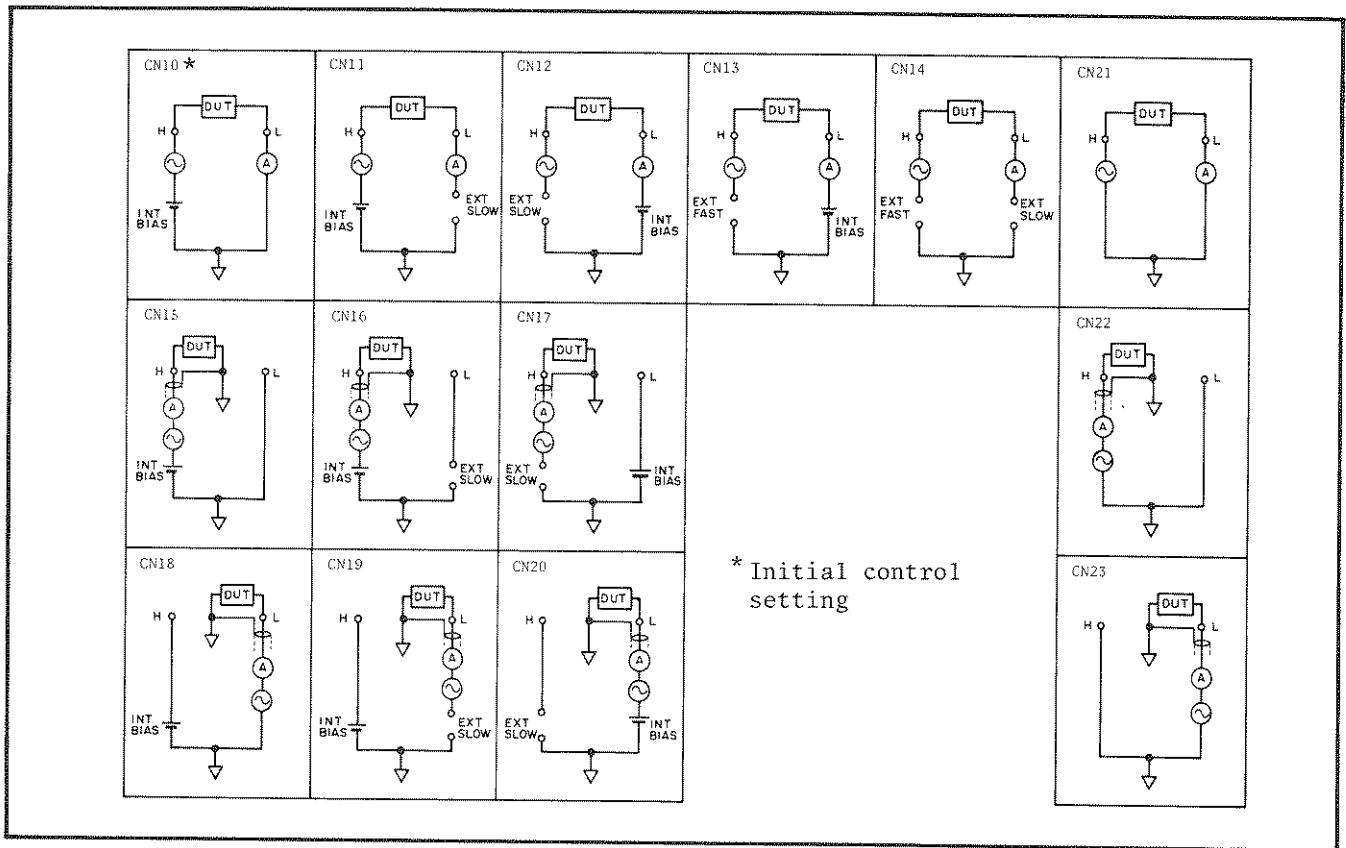

Figure 3-8. Connection Modes

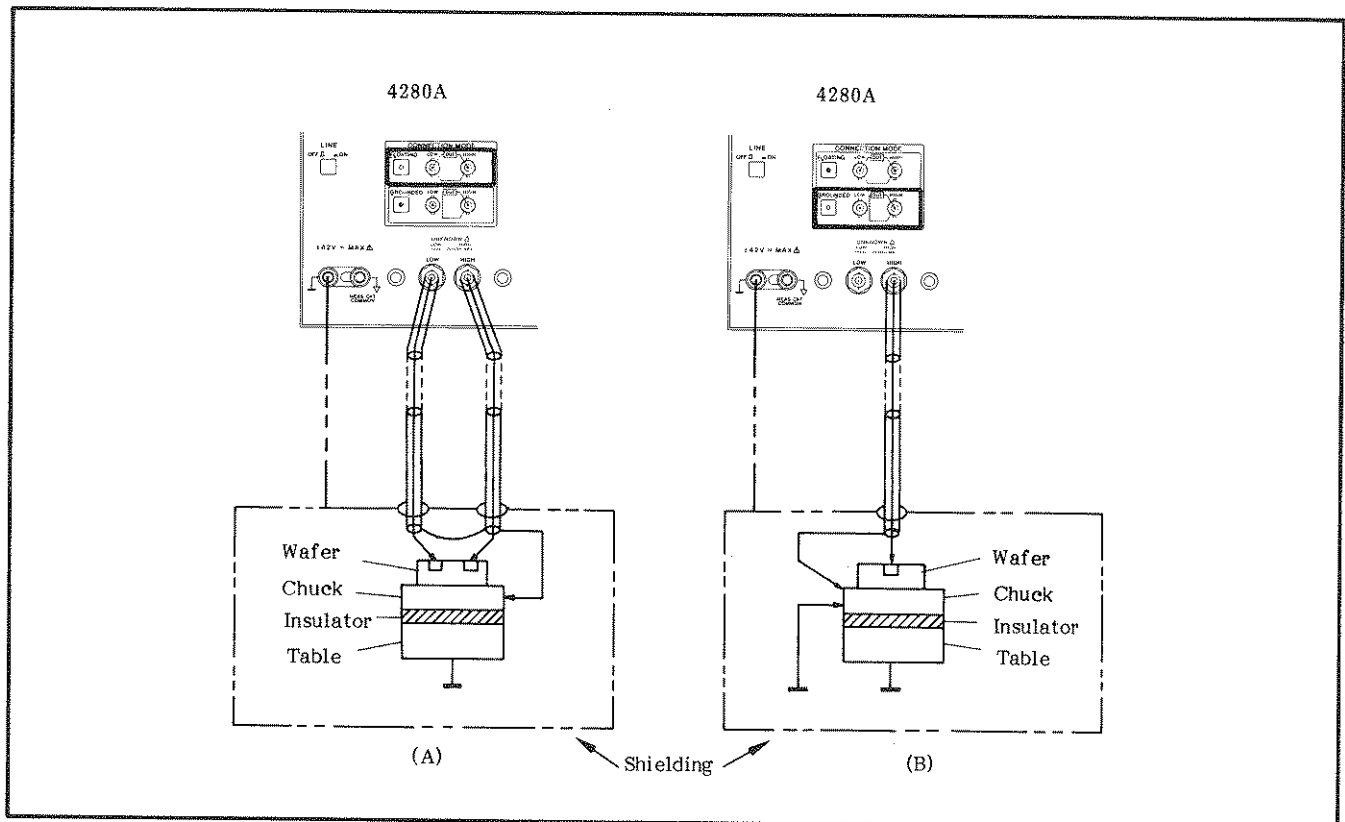

Figure 3-12. Connection Using a Wafer Prober

3-33. UNKNOWN TERMINALS

3-34. Generally, mutual inductance between test leads, noise from nearby equipment, and the residuals and strays of conventional connection methods adversely affect the accuracy of high frequency impedance measurements. To neutralize, or effectively eliminate, these error sources and thereby ensure optimum measurement accuracy, the 4280A employs a two-terminal pair connection method. The UNKNOWN terminals consist of two female BNC connectors: HIGH and LOW. See Figure 3-9. The arrangement is an expanded two terminal method with a built-in guard structure (three terminal method). The two-terminal pair method combines the advantages of the three terminal method at low frequencies down to dc, while providing shielding and a return path to prevent mutual inductance. The advantage of the two-terminal pair configuration is the outer shield, which provides a return path for the test signal current. Since the same current that flows through the center conductors also flows through the outer shields, but in opposite directions, no magnetic fields are generated around the conductors; the magnetic fields produced by the currents through the inner and outer conductors completely cancel each other. Thus, the measurement signal current does not cause measurement error. Also, because the two-terminal pair configuration uses 50Ω coaxial cables, distortion-free high speed bias pulses can be used for C-t measurements.

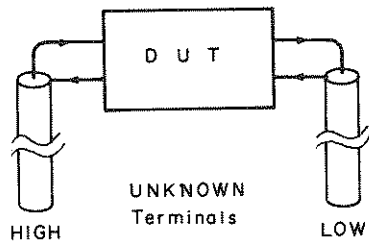

Figure 3-9. Two-Terminal Pair Configuration

3-35. HOW TO CONNECT A TEST SAMPLE

3-36. The methods of connecting floating and grounded devices are described below.

Connecting a floating device:

1. Select a floating connection mode--CN10 through CN14. The procedure is given in paragraph 3-31.

2. Connect the device to be tested between the center conductors of the HIGH and LOW UNKNOWN terminals, as shown in Figure 3-10.
3. Interconnect the outer conductors of the UNKNOWN terminals as close as possible to the device under test. See Figure 3-10.

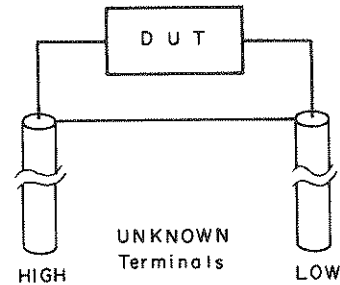

Figure 3-10. Floating Test Sample Connection

Connecting a grounded device:

1. Select a grounded connection mode--CN15 through CN20. The procedure is given in paragraph 3-31.
2. If the connection mode selected in step 1 is CN15, CN16, or CN17, connect the device to be tested between the center conductor and the outer conductor of the HIGH UNKNOWN terminal. If CN18, CN19, or CN20 was selected, though, connect the device to the LOW UNKNOWN terminal.
3. Connect the outer connector of the UNKNOWN terminal to the grounded side of the device under test. Refer to Figure 3-11.

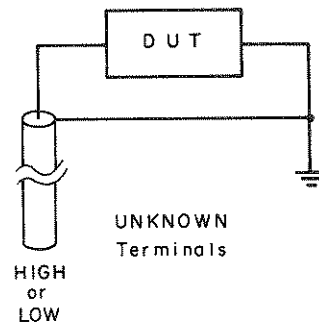
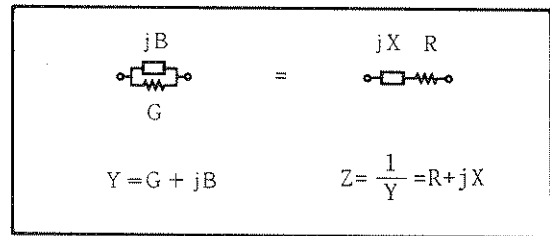

Figure 3-11. Grounded Test Sample Connection

3-37. Figure 3-12 shows two methods of using a wafer prober to connect a test sample to the 4280A. If the chuck of the wafer prober is not grounded, as shown in (A), the test sample is considered floating. Conversely, if the chuck is grounded, as in (B), the test sample, which is in contact with the chuck, is considered grounded.



Note

If the impedance between the grounded terminal of the sample and ground is low, disconnect the shorting strap that interconnects the ground terminal (⊥) and the MEAS CKT COMMON terminal (∇) on the front panel.

$$R + jX = \frac{1}{G + jB}$$

$$= \frac{G}{G^2 + B^2} - j \frac{B}{G^2 + B^2}$$

Expanding, we have

3-38. EQUIVALENT CIRCUITS

3-39. Any complex impedance can be represented by a simple series or parallel equivalent circuit consisting of a single resistive element and a single reactive element. This is possible because both equivalent circuits have identical impedances at a given test frequency if the equivalent circuit elements are properly established. The 4280A measures the capacitance, C, and conductance, G, of the equivalent parallel circuit of the device connected to the UNKNOWN terminals.

$$R - j \frac{1}{\omega C_s} = \frac{G}{G^2 + \omega^2 C_p^2} - j \frac{\omega C_p}{G^2 + \omega^2 C_p^2}$$

3-40. The capacitance value obtained from an equivalent parallel circuit measurement will differ from the value obtained from an equivalent series circuit measurement. The difference is due to the loss of the device being measured. The higher the loss, the larger the difference. The impedance of the device under test, whether measured as an equivalent parallel circuit or equivalent series circuit, is the same at any given frequency. This can be proven mathematically, as follows.

where C_p is the equivalent parallel circuit capacitance (B/ω) and C_s is the equivalent series circuit capacitance ($-1/\omega X$). Obviously, if the device under test has no losses—that is, if series resistance, R , and parallel conductance, G , are both zero—equivalent series capacitance, C_s , and equivalent parallel capacitance, C_p , will be equal. The correlation between C_s and C_p can be easily determined by using a simple conversion formula that considers the dissipation factor. Refer to Table 3-5. In short, capacitance values obtained from equivalent series circuit and equivalent parallel circuit measurements are nearly equal when the dissipation factor, D , of the device is less than 0.03. The dissipation factor of a component measured at a given frequency will be the same for both series and parallel equivalents.

Table 3-5. Dissipation Factor Equations and Equivalent Circuit Conversion Formulas

Equivalent Circuit	Dissipation Factor	Conversion to Other Modes
	$D = \frac{G}{\omega C_p} = \frac{1}{Q}$	$C_s = (1 + D^2) C_p, R = \frac{D^2}{1 + D^2} \cdot \frac{1}{G}$
	$D = \omega C_s R = \frac{1}{Q}$	$C_p = \frac{1}{1 + D^2} C_s, G = \frac{D^2}{1 + D^2} \cdot \frac{1}{R}$

3-41. INTERNAL ERROR CORRECTION

3-42. The 4280A is equipped with an automatic error correction function that virtually eliminates the effects of error-causing strays and residuals inherent in the test leads and test fixtures used to connect test samples to the UNKNOWN terminals. There are three CORRECTION procedures, one for each of the following connection methods:

- (1) The furnished 16080A Test Fixture or another direct connection type test fixture electrically identical to the 16080A is used.
- (2) The 16082A 1m Test Leads are used.
- (3) The 16081A 2m Test Leads or user-fabricated test leads of up to 5 meters are used. The latter must be fabricated from standard 50Ω coaxial cable--P/N: 8120-4195--and the HIGH and LOW leads must be of equal length.

The error CORRECTION procedures for the preceding connection methods are as follows:

(1) Direct Connect Test Fixture

- (a) Connect the test fixture directly to the UNKNOWN terminals.
- (b) Select 0m with the CABLE LENGTH key.
- (c) Connect nothing to the test fixture.
- (d) Set the instrument controls--e.g., connection mode, measurement mode, bias voltage, signal level, and so on--as appropriate for the desired measurement.
- (e) Press the ZERO OPEN button. Dashes will appear on C and G displays, and $\square - \square P$ will appear on the V-t display. Measurements will resume after about one to one and a half seconds.
- (f) Turn on the error correction function by pressing the CORRECTION ENABLE key. Make sure the ENABLE key indicator lamp is lit.

(2) 1 Meter Test Leads

- (a) Connect one end of the test leads to the HIGH and LOW UNKNOWN terminals. The other ends can be left unconnected, connected to a connector plate (e.g., P/N: 16081-60000, furnished with the 16082A Test Leads), or connected to a test fixture.
- (b) Select 1m with the CABLE LENGTH key.
- (c) Connect nothing to the test sample end of the cables.
- (d) Repeat steps (d), (e), and (f) of procedure (1).

(3) 0 to 5 Meter Test Leads

- (a) Connect one end of the test leads to the HIGH and LOW UNKNOWN terminals. Leave the other ends unconnected.
- (b) Select 0 - 5m with the CABLE LENGTH key.
- (c) Press the CAL key (indicator should light), and then press the START button. Dashes will appear on the C and G displays, and $\square b L$ will appear on the V-t display. Measurements will resume after one to one and a half seconds.
- (d) Connect a connector plate (e.g., P/N: 16081-60000, furnished with the 16081A Test Leads) or test fixture to the ends of the test leads.
- (e) Repeat steps (d), (e), and (f) of procedure (1).

Note

If the measurement requires dc biasing from an external source, connect the bias source to the appropriate EXT BIAS connector--FAST or SLOW--on the rear panel.

Note

Error correction procedures (2) and (3) compensate for the residuals and strays of the test leads and, if used, connector plate or test fixture. Cables, wires, or other devices used to connect a test sample to the test leads, connector plate, or test fixture will have residual inductance that will cause an additive measurement error. If the amount of residual inductance is known, the percent error for measured capacitance can be approximated from the following graph.

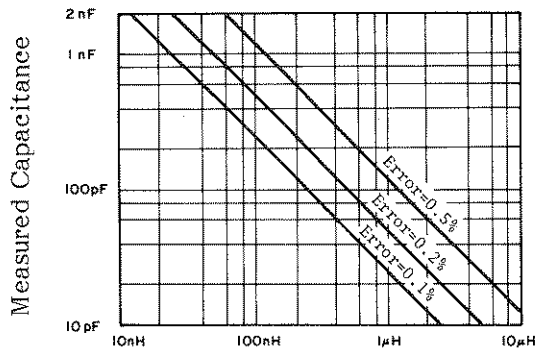

Residual Inductance

3-43. MATH FUNCTION

3-44. When many components of similar value are to be tested, it may be more practical to measure the difference between the value of the sample and a predetermined, or ideal, reference value than measuring the sample value itself. When the purpose of the measurement is to observe the change of a sample's value versus changes in dc bias voltage, time, etc., a direct measurement of this change makes examination more meaningful and easier. When a MATH function is enabled, calculated values (Δ , %, $\Delta\%$) are displayed instead of measured values.

3-45. Each MATH function is described below.

 Δ (difference):

Calculates and displays the difference between measured values and a previously stored reference value. The formula used to calculate the difference is

$$A - B$$

where A is the measured value of the sample and B is the stored reference value.

% (percent):

Calculates the ratio between measured values and a previously stored reference value. The result is displayed as a percentage. The formula used is

$$\frac{A}{B} \times 100(\%)$$

where A is the measured value of the sample and B is the stored reference value.

 $\Delta\%$ (percent difference):

Calculates and displays the difference between measured values and a previously stored reference value as a percentage of the reference value. The formula used is

$$\frac{A - B}{B} \times 100(\%)$$

where A is the measured value of the sample and B is the stored reference value.

Reference values can be stored using one of the following procedures. The choice depends on the measurement objectives.

- (1) Storing the measured value of a reference standard:
 - (a) Set the instrument controls as appropriate for the desired measurement.
 - (b) Connect the reference standard to the 4280A.
 - (c) Perform a measurement.
 - (d) Press the STORE DISPL C·G key. The V·t display will briefly display $r \ E \ F$, and the measured capacitance and conductance of the standard will be stored.
- (2) Storing an arbitrary value:
 - (a) Set the instrument controls as appropriate for the desired measurement.
 - (b) Press the blue key (indicator lamp will light), and then press the C-REF key. Previously stored reference values will appear on the C and G displays, and $r \ E \ F$ will appear on the V·t display.

- (c) Key in the desired C reference value using the numeric keys. The new value will appear on the C display as you key it in, and will be in picofarads.
- (d) Press the ENTER key. The indicator lamp on the blue key will go off.

Note

The above procedure is for storing a C reference value. By pressing the G-REF key instead of the C-REF key in step (b), however, this procedure can be used for storing a G reference value. The stored value will be in microsiemens.

After the desired reference values have been stored, press the Δ , %, or $\Delta\%$ key to turn on the MATH function. The indicator at the center of the key will light. To turn off the MATH function press the same key again. The indicator will go off. The maximum allowable C and G reference values are $\pm 199999\text{pF}$ and $\pm 19999\mu\text{S}$, respectively. Once stored, reference values remain until the 4280A is turned off, self test is performed, or new reference values are entered. If the STORE DISPL C·G key is pressed while FUNCTION is set to C or G, only the reference value for the selected function will be stored. The other reference value will be unchanged.

Note

When the CORRECTION function is enabled, the results of a % or $\Delta\%$ MATH operation may differ from expected results, especially when the number of display counts is low. For example, if the stored reference value and the displayed measured value are the same, you would expect 100.00(%) to appear on the display when the % MATH key is pressed. But because MATH calculations use raw measurement data, which must be rounded for display, rather than the displayed measured value, the value displayed when the % key is pressed may not be 100.00(%)

3-46. DIGIT SHIFT

3-47. The C \diamond and G \diamond DIGIT SHIFT keys reduce the number of digits displayed on the C display and G display, respectively. Each time one of these keys is pressed, the least significant digit (right-most digit) of the number appearing on the corresponding display is deleted. The new number is automatically rounded and shifted one display position to the right. Only digits to the right of the decimal point can be deleted. The complete number can be redisplayed by repeatedly pressing the DIGIT SHIFT key until the key indicator lamp goes off. If the instrument control settings are changed--e.g., C·G RANGE, MEAS SPEED, SIG LEVEL--and the shifted number of digits is not suitable for the display format, the DIGIT SHIFT function will be automatically reset and the complete number will be displayed.

3-48. INTERNAL DC BIAS SOURCE SAFETY FEATURES

3-49. The 4280A is equipped with an internal dc bias source capable of outputting up to $\pm 100\text{V}$, enough to cause serious injury to the operator. To protect the operator against electrical shock from voltages exceeding $\pm 42\text{V}$, the 4280A has several built-in safety features.

3-50. When the INT BIAS switch on the front panel is set to the $\pm 42\text{V MAX}$ position, output from the internal dc bias source is limited to $\pm 42\text{V}$. Control PARAMETERS--DC V, START V, STOP V, PULSE V, and MEAS V--for the internal dc bias source cannot be set to values exceeding $\pm 42\text{V}$ when the INT BIAS switch is in this position. If, however, one of these PARAMETERS was set to a value exceeding $\pm 42\text{V}$ before the INT BIAS switch was set to the $\pm 42\text{V MAX}$ position, output from the internal dc bias source will be disabled and an error code will be displayed on the V·t display when the SWEEP/V OUTPUT key is pressed. Similarly, if the setting of the INT BIAS switch is changed from $\pm 100\text{V MAX}$ to $\pm 42\text{V MAX}$ while the internal dc bias source is outputting more than $\pm 42\text{V}$, or during a swept measurement in which the output will exceed $\pm 42\text{V}$, output from the internal dc bias source will be disabled and an error code will appear on the V·t display.

3-51. When the INT BIAS switch is in the $\pm 100V$ MAX position, the REMOTE ON/OFF BNC connector adjacent to the switch must be properly terminated by a user-supplied switch connected as shown in the following illustrations. When the switch is closed, as shown in the left illustration, the internal dc bias source is enabled and will output voltage in accordance with the PARAMETER settings when the SWEEP/V OUTPUT key is pressed. When the switch is open, as shown in the right illustration, the internal dc bias source is disabled; voltage is not output when the SWEEP/V OUTPUT key is pressed.

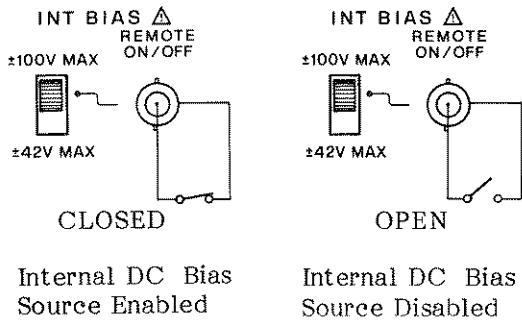

Internal DC Bias Source Enabled

Internal DC Bias Source Disabled

The switch connected to the REMOTE ON/OFF connector can be used to detect potentially hazardous conditions. For example, it can be used to detect the open/closed state of a lid on a test fixture. When the lid is open, exposing the measurement terminals, the switch will be open, disabling output from the internal dc bias source. Conversely, when the lid is closed, making it impossible for the operator to touch the measurement terminals, the switch will be closed, enabling output from the internal dc bias source.

WARNING

DO NOT USE THE FURNISHED BNC SHORTING CAPS (P/N: 1250-0929) TO SHORT THE REMOTE ON/OFF CONNECTOR DURING NORMAL OPERATION. DOING SO MAY EXPOSE THE OPERATOR TO DC VOLTAGE UP TO $\pm 100V$.

WARNING

DO NOT LEAVE THE EXTERNAL REMOTE ON/OFF SWITCH IN THE CLOSED POSITION. DOING SO MAY EXPOSE AN UNAWARE OPERATOR TO DC VOLTAGES UP TO $\pm 100V$.

Note

The REMOTE ON/OFF connector shorting cap (P/N: 1250-0929) is used for performance testing only. Performance Tests are described in Section IV.

Note

The information given in paragraphs 3-48 through 3-51 does not apply when the 4280A is set to connection mode CN14, CN21, CN22, or CN23, and is valid only when biasing from the internal dc bias source.

3-52. USABLE ACCESSORIES

3-53. Table 3-6 lists the accessories—test fixture and test leads—that can be used with the 4280A. Refer to Table 1-3 for more details.

Table 3-6. Usable Accessories

Model	Description	DC Voltage Limitations
16080A	Test Fixture	-42V to +42V
16081A	Test Leads (2m)	-100V to +100V
16082A	Test Leads (1m)	-100V to +100V

Note

If test leads having lengths different from that of the 16082A are required, they can be made from standard 50Ω coaxial cable, available from Hewlett-Packard as P/N: 8120-4195. However, such user-fabricated test leads must not be longer than five meters, and HIGH and LOW leads must be the same length.

3-54. EXTERNAL TRIGGERING

3-55. The 4280A can be externally triggered by connecting an external triggering device to the EXT TRIGGER connector on the rear panel and setting the TRIGGER/SWEEP MODE control on the front panel to EXT. The instrument is triggered (measurement is made) each time a positive-going TTL level pulse is applied to this connector (refer to Figure 3-13). External triggering can also be done by alternately shorting and opening the center conductor of the EXT TRIGGER connector to ground (chassis).

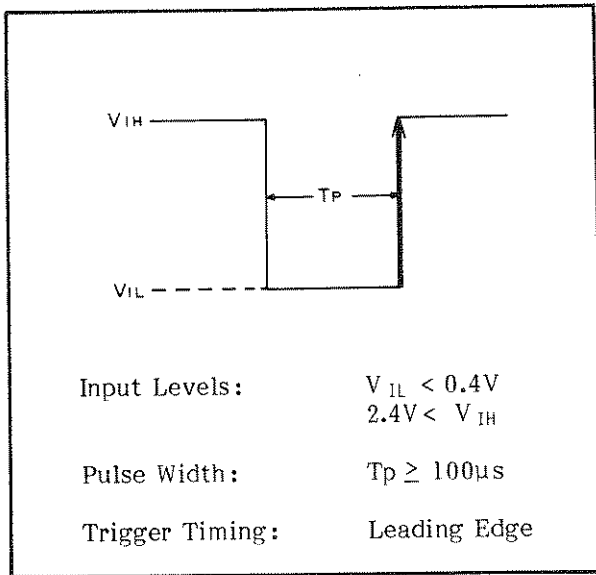

Figure 3-13. External Triggering Signal

3-56. EXTERNAL ERROR CORRECTION

3-57. The automatic error correction function described in paragraph 3-41 is intended for general measurement applications. It has two disadvantages, however. First, it significantly reduces measurement speed and secondly, it can not be used when the HIGH and LOW leads are of different lengths or when the stray capacitance between the HIGH terminal and ground or between the LOW terminal and ground exceeds approximately 1pF. By using a computer to perform error correction, however, you can shorten measurement time and at the same time obtain accurate measurement results under various test lead and stray capacitance conditions.

External error correction requires a computer with HP-IB interface capability to read the raw, uncorrected measurement data from the 4280A and then automatically perform the required error correction. Complete details on external error correction can be found in the appendix.

C MODE**3-58. C MODE**

3-59. The 4280A is set to C mode when the internal dc bias source is set to \equiv or OFF. In C mode, the 4280A measures the capacitance, C, and conductance, G, of the device under test (DUT). The DUT can be dc biased at 0V to $\pm 100V$ from the internal dc bias source or at up to $\pm 200V$ from an external bias source. Paragraphs 3-60 through 3-69 describe instrument operations and functions that are unique to C mode operation. For information concerning basic operations, refer to paragraphs 3-1 through 3-57.

Note

The table below lists the recommended connection modes and INTERNAL BIAS modes for C mode measurements.

DC Bias Source	Sample Connection		
	Floating	Grounded	
	HIGH-LOW	HIGH-GND	LOW-GND
Internal Bias	CN10 \equiv	CN15 \equiv	CN20 \equiv
Internal and External Bias	CN11 \equiv	/	/
External Bias Using a Bias Network	CN10 OFF	CN15 OFF	CN18 OFF

3-60. INTERNAL DC BIAS SOURCE

3-61. The internal dc bias source can output dc voltages up to $\pm 100V$ over three ranges—1V, 10V, and 100V—when INTERNAL BIAS is set to \equiv . Table 3-7 lists the coverage and setting resolution for each range.

Table 3-7. Internal DC Bias Source Ranges

Range	Range Coverage	Resolution
1V	-1.999V to +1.999V	1mV
10V	-19.99V to +19.99V	10mV
100V	-100.0V to +100.0V	100mV

Ranging (auto or fixed) is determined by the V LIMIT value (described in paragraph 3-64). In auto-ranging mode, the range that provides the maximum number of digits on the V·t display is automatically selected.

Table 3-8. Auto-Ranging Mode

Output Voltage Setting	Range
$\pm(0.000 - 1.999)V$	1V
$\pm(2.00 - 19.99)V$	10V
$\pm(20.0 - 100.0)V$	100V

The current output capability of the internal dc bias source is approximately $\pm 6mA$.

3-62. INTERNAL DC BIAS OPERATION

3-63. Figure 3-15 provides a step-by-step procedure for setting the output voltage of the internal dc bias source. To apply the specified dc bias voltage to a DUT, press the SWEEP/V OUTPUT key. The red V OUTPUT lamp will light to indicate that the internal dc bias source is outputting voltage.

Note

The V OUTPUT lamp blinks when the current through the DUT exceeds the output capability of the internal dc bias source.

WARNING

IF THE V OUTPUT LAMP BLINKS WHEN NOTHING IS CONNECTED TO THE UNKNOWN TERMINALS, THE 4280A IS MALFUNCTIONING AND DANGEROUS VOLTAGE MAY BE PRESENT AT THE UNKNOWN TERMINALS.

Note

Output voltage can be changed while the V OUTPUT lamp is lit. However, if autoranging mode is set and the new output voltage causes a range change, output voltage will momentarily drop to 0V. To prevent this, use a fixed range. Refer to paragraph 3-64 for fixed ranging mode.

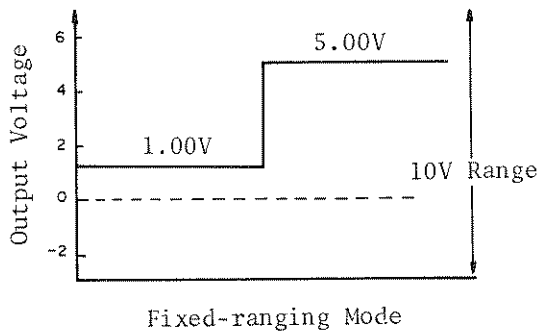
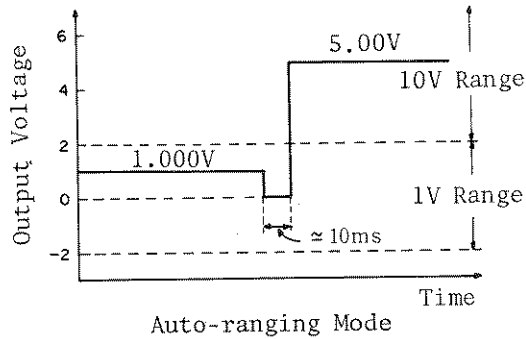

3-64. INTERNAL DC BIAS SOURCE OUTPUT LIMIT AND RANGE CONTROL

3-65. Output from the internal dc bias source can be limited to any value between 0 and 100V. The specified limit value (V LIMIT) is bipolar; that is, it applies to both positive and negative output voltages. For example, if V LIMIT is set to 10V, output from the internal dc bias source will be limited to $\pm 10V$. If an output value exceeding $\pm 10V$ is entered, it will be automatically set to +10V if positive, or -10V if negative.

Note

This function is applicable in C mode only.

Note

This function does not override the setting of the INT BIAS switch described in paragraph 3-48.

The V LIMIT value also determines the output range for the internal dc bias source. Refer to Table 3-9. The procedure for setting V LIMIT is given in Figure 3-16.

Table 3-9. Internal DC Bias Source V LIMIT vs Range

V LIMIT Value	Ranging Mode	Range
0V*	Auto	Automatically selected
0.001V to 1.999V	Fixed	1V
2.00V to 19.99V	Fixed	10V
20.0V to 100.0V	Fixed	100V

*When V LIMIT = 0V, output is not limited.

3-66. EXTERNAL DC BIAS

3-67. For measurements that require bias voltage greater than $\pm 100V$ or bias current greater than $\pm 6mA$, use an external dc bias source. The example shown in Figure 3-17(a) is applicable for bias voltages up to $\pm 142V$ and bias currents up to $\pm 6mA$. The example shown in Figure 3-17(b) is applicable for bias voltages up to $\pm 200V$ and bias currents up to $\pm 100mA$.

WARNING

IF DC VOLTAGES EXCEEDING $\pm 42V$ ARE USED TO BIAS THE DEVICE UNDER TEST, A GROUNDED COVER OR SIMILAR DEVICE MUST BE USED TO PHYSICALLY PREVENT THE OPERATOR FROM TOUCHING ELECTRICALLY LIVE PARTS.

3-68. MEASUREMENT EXAMPLE

3-69. The procedure for measuring a floating sample biased from the internal dc bias source is given in Figure 3-18. Instructions for performing the same measurement under remote control via the HP-IB are given in Figure 3-19.

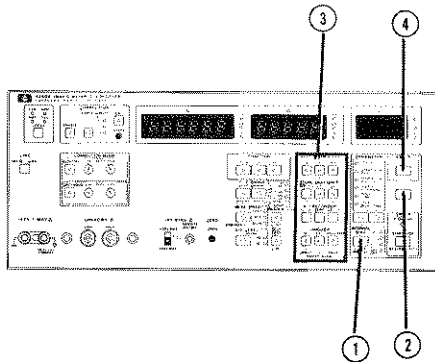

Procedure for Setting the Output Voltage of the Internal DC Bias Source



1. Select \equiv with the INTERNAL BIAS key (1).
2. Press the blue key (2). The indicator lamp at the center of the key will light and the existing output voltage value will appear on the V-t display.
3. Key in the desired output voltage value with the numeric keys (3). The new voltage value will appear on the V-t display as you key it in.
4. Press the ENTER key (4).

Note

Output voltage range is determined by the setting of the INT BIAS switch. Refer to the following table.

INT BIAS Switch Setting	Output Voltage Range
±100V MAX 	0V ~ ± 42V
±42V MAX 	0V ~ ± 100V

If an output voltage value exceeding the limit set by the INT BIAS switch is set, error code E-6.3 will appear on the V-t display. The last valid output voltage will remain in effect.

Figure 3-15. Procedure for Setting Internal DC Bias Voltage

Procedure for Setting the Limit Voltage (V LIMIT) of the Internal DC Bias Source

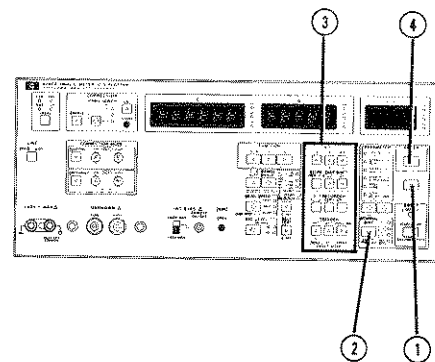

1. Press the blue key, (1). The indicator lamp at the center of the key will light.
2. Press the V LIMIT/RNG HOLD key (2). The existing V LIMIT setting will appear on the V-t display. If zero was the last value entered, *AUTO* will be displayed.
3. Key in the desired V LIMIT value with the numeric keys (3). The new V LIMIT will appear on the V-t display as you key it in.
4. Press the ENTER key (4).

Note

V LIMIT can be set only when the 4280A is in C mode.

Note

Once V LIMIT is set, the internal dc bias voltage range is fixed. Refer to Table 3-8.

Note

When V LIMIT = 0V is set, ranging for the internal dc bias source is set to auto.

Figure 3-16. Procedure for Setting V LIMIT

External DC Biasing

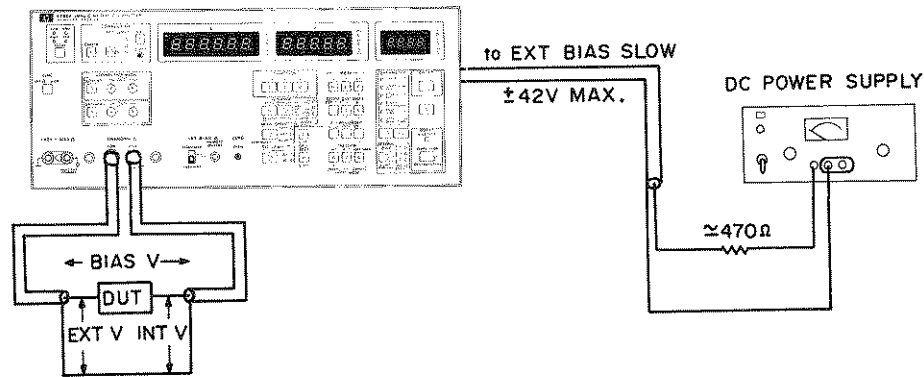

$$\text{BIAS V} = \text{INT V} - \text{EXT V}$$

where BIAS V is the bias voltage applied to the DUT,
 INT V is the output from the internal dc bias source,
 and EXT V is the externally supplied bias voltage.

4280A Control Settings:

Connection Mode CN11
 INTERNAL BIAS ==

CAUTION

USE A CURRENT LIMITING RESISTOR (approximately 470Ω) IN THE HIGH LEAD OF THE EXTERNAL SOURCE TO PROTECT THE 4280A AGAINST EXCESSIVE CURRENT. IF THE DC POWER SUPPLY HAS CURRENT LIMITING CAPABILITIES, SET THE OUTPUT CURRENT LIMIT TO 6mA.

Note

If bias current flows through the DUT, the actual bias voltage applied to the DUT may be lower than the specified voltage due to the dc resistance of the bias circuit.

Figure 3-17(a). External DC Bias Application up to ±142V

External DC Biasing

FLOATING Sample

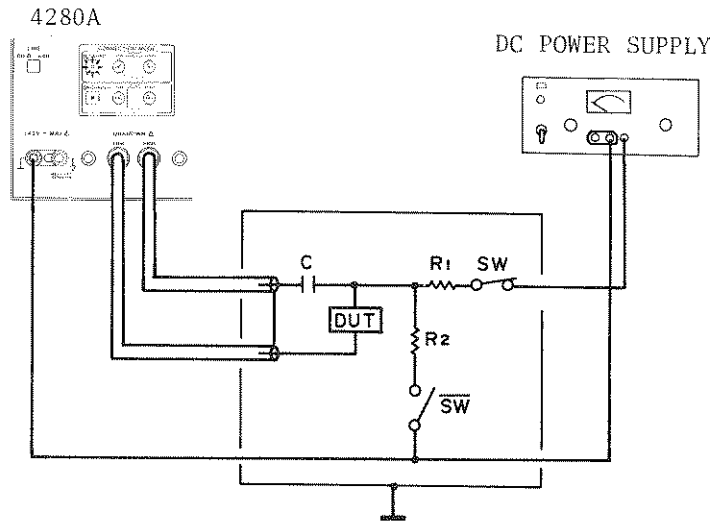

GROUNDING Sample

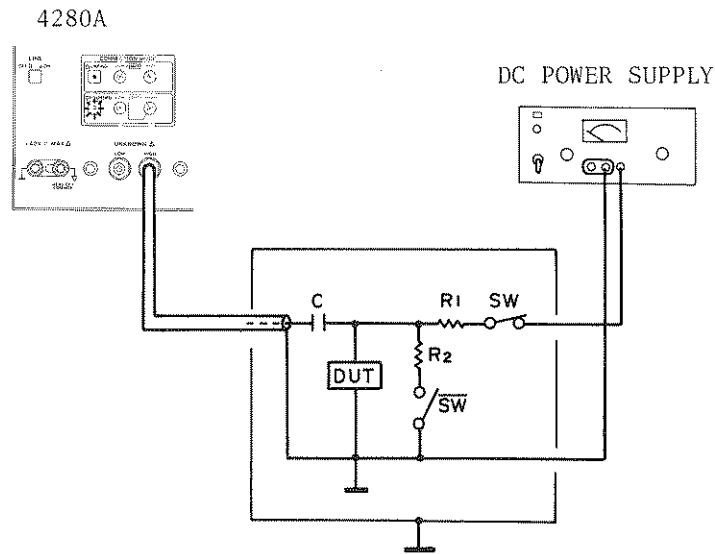

* When the DUT is connected to the UNKNOWN LOW terminal, select connection mode CN18.

Figure 3-17(b). External DC Bias Application up to ±200V (Sheet 1 of 2)

C: DC blocking capacitor, $1\mu\text{F}$, minimum 250V working voltage

R_1 : Current limiting resistor, $100\text{k}\Omega$ or more

R_2 : Discharge resistor, 100Ω or more, minimum 20W rating

$\overline{\text{SW}}$: Discharge switch. OPEN during measurement, CLOSED to discharge the dc blocking capacitor and DUT

SW: Biasing switch

Note

Reducing the value of the blocking capacitor, C, degrades measurement accuracy.

CAUTION

DO NOT SHORT THE HIGH AND LOW UNKNOWN TERMINALS OF THE 4280A WHEN THE DUT AND THE DC BLOCKING CAPACITOR ARE CHARGED. ALSO, TO PREVENT DAMAGE TO THE 4280A, THE FOLLOWING PRECAUTIONS MUST BE TAKEN:

- * THE DC BLOCKING CAPACITOR MUST NOT EXCEED $1\mu\text{F}$.
- * ONLY CONNECTION MODE CN10, CN15 OR CN18 CAN BE USED.
- * INTERNAL BIAS MODE MUST BE SET TO OFF.

Figure 3-17 (b). DC Bias Application up to $\pm 200\text{V}$ (Sheet 2 of 2)

Example of C Mode Measurement

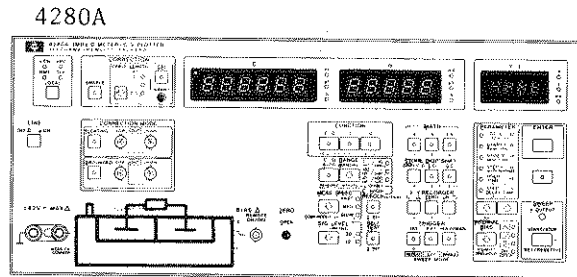

1. Set the INT BIAS limit switch as appropriate for the dc bias voltage that will be used in the measurement. Refer to the table below.

4. Perform internal or external error correction, as described in paragraphs 3-41 and 3-56, respectively.

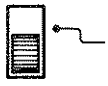
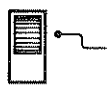
DC V Range	INT BIAS Switch
+ 42 V ~ - 42 V	<p>±100V MAX</p>  <p>±42V MAX</p>
+100V ~ -100V	<p>±100V MAX</p>  <p>±42V MAX</p>

Note

If external error correction is to be performed, turn off internal error correction function by pressing the ENABLE Key.

Note

If necessary, set the internal dc bias limit voltage (V LIMIT). Refer to paragraph 3-64.

2. Connect the test fixture or test leads to the UNKNOWN terminals.
3. Turn on the instrument, and then press the FLOATING CONNECTION MODE Key.

Note

To measure a grounded DUT, press the GROUNDED Key.

Figure 3-18. C Mode Measurement Example (Sheet 1 of 2)

5. Set the output voltage of the internal dc bias source. Refer to paragraph 3-64.
6. Connect the sample to the test fixture.
7. Press the SET/RESET key to activate the internal dc bias source. The red V OUTPUT lamp will light while voltage is being output from the internal dc bias source.
8. Read the C and G measurement values displayed on the C display and G display, respectively.

Note

Measurement accuracy, specified in Table 1-1, is guaranteed after the 4280A has been allowed to warm up at least thirty minutes.

9. Press the SET/RESET key to deactivate the internal dc bias source, and then remove the DUT from the test fixture.

Note

The red V OUTPUT lamp will go off when the SET/RESET key is pressed.

Note

When the INT BIAS switch is set to $\pm 100V$ MAX, the REMOTE ON/OFF connector must be short terminated to enable output from the internal dc bias source. Refer to paragraph 3-48.

WARNING

BE SURE TO OPEN TERMINATE THE REMOTE ON/OFF CONNECTOR WHEN THE INTERNAL DC BIAS SOURCE IS NOT IN USE. THIS WILL PREVENT ACCIDENTAL OUTPUT OF HIGH VOLTAGES, UP TO $\pm 100V$

Note

The REMOTE ON/OFF connector shorting cap (P/N: 1250-0929) is required for performance testing.

Note

If the dc current through the DUT exceeds 5mA (approximate), the V OUTPUT lamp will blink off and on.

Figure 3-18. C Mode Measurement Example (Sheet 2 of 2)

Example of HP-IB Controlled C Mode Measurement

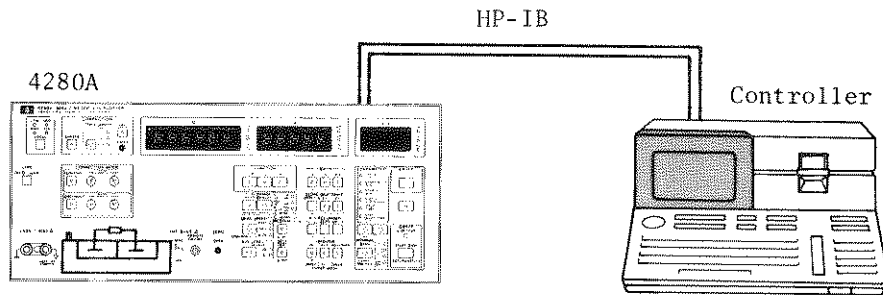

1. Manually set the INT BIAS switch as appropriate for the dc bias voltage that will be used in the measurement. Refer to the table below.

DC V Range	INT BIAS Switch
+ 42V ~ - 42V	<p>±100V MAX</p> <p>±42V MAX</p>
+ 100V ~ - 100V	<p>±100V MAX</p> <p>±42V MAX</p>

Note

After the 4280A is turned on, its HP-IB address will appear briefly on the C display. This address must be used to program the instrument via the HP-IB. In the examples that follow, the factory set address, 17 (shown below), is used. For more information on the HP-IB address, refer to paragraph 3-174.



4. Set the 4280A to FLOATING measurement mode.

OUTPUT 717; "FL"

Note

To set the GROUNDED measurement mode, use the following program code:

OUTPUT 717; "GN"

2. Connect the test fixture or test leads to the UNKNOWN terminals.
3. Turn on the instrument.

Figure 3-19. HP-IB Controlled C Mode Measurement Example (Sheet 1 of 3)

- 5. Perform internal or external error correction, as described in paragraphs 3-41 and 3-56, respectively.

Note

If external error correction is to be performed, turn off the internal correct function. Use the following program code.

```
OUTPUT 717; "CE0"
```

Note

If necessary, set the internal dc bias limit voltage (V LIMIT). Refer to paragraph 3-62.

```
OUTPUT 717; "VL 10" ! V LIMIT=10 volts
```

Note

To change the internal dc bias voltage range selection to *Auto*, set the internal dc bias limit voltage to 0 volts.

- 6. Set the trigger mode to HOLD/MAN.

```
OUTPUT 717; "TR 3"
```

- 7. Set the internal dc bias voltage.

```
OUTPUT 717; "PV 5"! DC V=5 volts
```

Note

If a voltage exceeding the V LIMIT voltage is entered, the V LIMIT voltage is automatically set as the output voltage of the internal dc bias source.

- 8. Connect the DUT to the test fixture.

- 9. Activate the internal dc bias source.

```
OUTPUT 717; "VO1"
```

Note

The red V OUTPUT lamp will light while voltage is being output from the internal dc bias source.

Note

When the INT BIAS switch is set to ±100V MAX, the REMOTE ON/OFF connector must be short terminated to enable output from the internal dc bias source. Output from the internal dc bias source is disabled by open terminating the REMOTE ON/OFF connector. Refer to paragraph 3-48 for details on the REMOTE ON/OFF connector.

WARNING

BE SURE TO OPEN TERMINATE THE REMOTE ON/OFF CONNECTOR WHEN THE INTERNAL DC BIAS SOURCE IS NOT IN USE. THIS WILL PREVENT ACCIDENTAL OUTPUT OF HIGH VOLTAGES, UP TO ±100V.

Note

The REMOTE ON/OFF terminal shorting cap (P/N: 1250-0929) is required for performance testing.

Note

If the dc current through the device under test exceeds 5mA (approximate), the V OUTPUT lamp will blink off and on.

- 10. Trigger the instrument.

```
OUTPUT 717; "EX"
```

- 11. Read and print out the measurement results.

```
ENTER 717; A, B
PRINT A, B
```

Note

Accuracy of measurement results is specified after a thirty-minute warmup.

- 12. Deactivate the internal dc bias source.

```
OUTPUT 717; "VO0"
```

Figure 3-19. HP-IB Controlled C Mode Measurement Example (Sheet 2 of 3)

Note

The red V OUTPUT lamp will go off when the internal dc bias source is deactivated.

Note

Measurement accuracy, specified in Table 1-1, is guaranteed after the 4280A has been allowed to warm up at least thirty minutes.

Note

This sample program can be run on the following controllers.

- (1) HP 85 (with 00085-15003 I/O ROM)
- (2) HP 9835A/9835B (with 98332A I/O ROM)
- (3) HP 9845B (with 98412A I/O ROM)
- (4) HP 9816
- (5) HP 9826
- (6) HP 9836

Figure 3-19. HP-IB Controlled C Mode Measurement Example (Sheet 3 of 3)

C-V MODE**3-70. C-V MODE**

3-71. The 4280A is in C-V mode when the internal dc bias source is set to ⏏ or ⏏ . In C-V mode, the 4280A measures capacitance, C, and conductance, G, as functions of swept dc bias. Output from the internal dc bias source can be swept in either a single staircase (⏏) or double staircase (⏏) manner. Paragraphs 3-72 through 3-80 describe instrument operations and functions unique to C-V mode operation. For information concerning basic operations, refer to paragraphs 3-1 through 3-57.

Note

The following Table shows the recommended connection mode selection.

FLOATING	GROUNDED	
HIGH-LOW	HIGH-GND	LOW-GND
CN10	CN15	CN20

3-72. BIAS SWEEP PARAMETERS

3-73. To perform a swept bias measurement in C-V mode, five sweep parameters—START V, STOP V, STEP V, HOLD TIME and STEP DELAY TIME—must first be set. These parameters are described in paragraphs 3-74 through 3-83. Figure 3-20 shows the timing diagrams for both single staircase and double staircase sweeps. The figure also gives the procedure for setting the sweep parameters.

3-74. START V

3-75. START V (start voltage) sets the initial output voltage for bias sweeps made with the internal dc bias source. START V can be set to any value within the output range of the internal dc bias source as long as the value does not exceed the limit set by the INT BIAS switch (paragraph 3-48). Table 3-12 gives the setting resolution for each START V range.

Table 3-12. START V Resolution

START V Range	Resolution
$\pm(0.000 \sim 1.999) \text{ V}$	1 mV
$\pm(2.00 \sim 19.99) \text{ V}$	10 mV
$\pm(20.0 \sim 100.0) \text{ V}$	100 mV

3-76. STOP V

3-77. STOP V (stop voltage) sets the final voltage (⏏) or the peak voltage (⏏) for bias sweeps made with the internal dc bias source. Setting limitations and resolution for STOP V are identical to those for START V.

Note

If the resolution of the specified START V value is different from that of the specified STOP V value, the value that has the more sensitive resolution will be automatically rounded to match the resolution of the other value. Because of this rounding operation the value you key in may be different from the value appearing on the V · t display.

3-78. STEP V

3-79. STEP V (step voltage) sets the incremental voltage for bias sweeps made with the internal dc bias source. The settable range for STEP V is 0V to 200V. Table 3-13 gives the setting resolution for each STEP V range.

Table 3-13. STEP V Resolution

STEP V Range	Resolution
0.000V ~ 3.999V	1 mV
4.00V ~ 39.99V	10 mV
40.0V ~ 200.0V	100 mV

STEP V may be automatically rounded up or down to match the resolution of the START V and STOP V parameters when the bias sweep is executed. Also, if STEP V is set to 0.004 or lower when either START V or STOP V is higher than $\pm 1.999V$, the microprocessor will assume a STEP V value of 0.000V. When the bias sweep is executed, the internal dc bias source will output the specified START V voltage, and, after measurement has been made, will try to increment the output voltage by the specified STEP V value. Since 0.000V is assumed for STEP V, however, output cannot be incremented. If SINGLE SWEEP MODE is set, the sweep will stop after measurement has been made at the START V voltage; if REPEAT SWEEP MODE is set, measurements will be made repeatedly at the START V voltage.

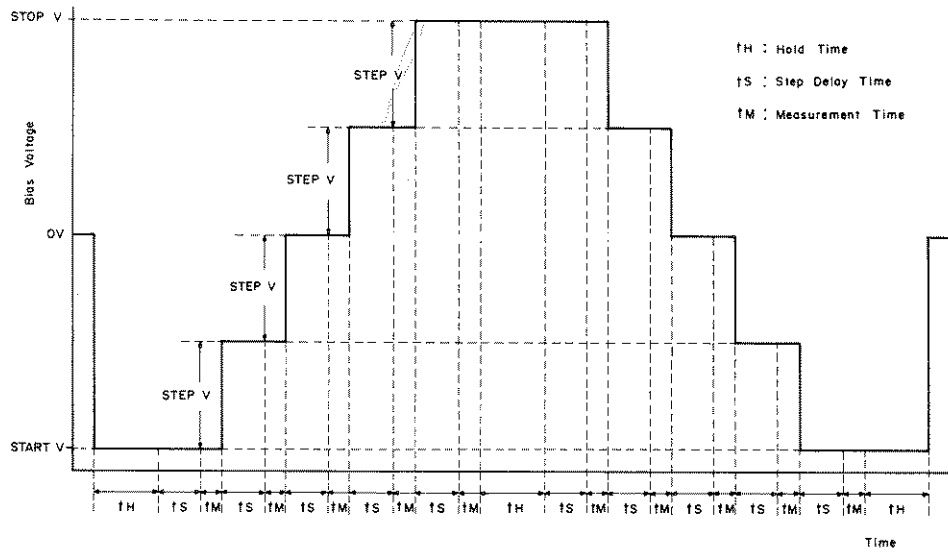
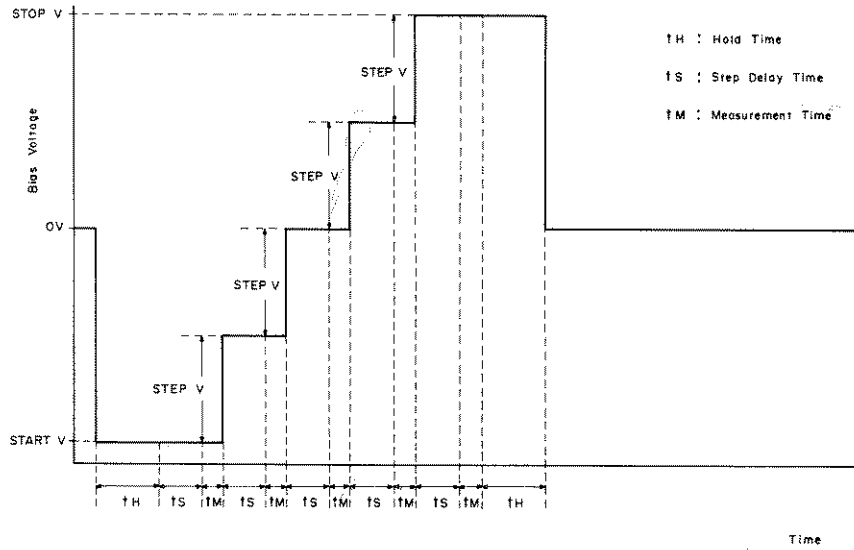





Figure 3-20. Bias Sweep Set-up Procedure (Sheet 1 of 3)

The procedure for setting up the internal dc bias source to perform a bias sweep is given below.

1. Select either  or  with the INTERNAL BIAS key.

[START V Setting]

2. Select the START V PARAMETER by repeatedly pressing the  or  PARAMETER key until the lamp adjacent to START V lights.
3. Press the blue key. The lamp at the center of the key will light and the existing START V value will appear on the V-t display.
4. Key in the desired START V value with the numeric keys. The new START V value will appear on the V-t display as you key it in.
5. Press the ENTER key. The lamp at the center of the blue key will go out.

[STOP V Setting]

6. Press the  PARAMETER key once to select STOP V.
7. Press the blue key. The lamp at the center of the key will light and the existing STOP V value will appear on the V-t display.
8. Key in the desired STOP V value with the numeric keys. The new STOP V value will appear on the V-t display as you key it in.
9. Press the ENTER key.

[STEP V Setting]

10. Press the  PARAMETER key once to select STEP V.
11. Press the blue key. The lamp at the center of the key will light and the existing STEP V value will appear on the V-t display.
12. Key in the desired STEP V value with the numeric keys. The new STEP V value will appear on the V-t display as you key it in.
13. Press the ENTER key.

[HOLD TIME Setting]

14. Press the  PARAMETER key once to select HOLD TIME.
15. Press the blue key.
16. Key in the desired HOLD TIME value with the numeric keys. If the unit for HOLD TIME is milliseconds, press the ms key (INTERNAL BIAS key). The ms unit indicator lamp adjacent to the V-t display will light.
17. Press the ENTER key.

[STEP DELAY TIME Setting]

18. Press the  PARAMETER key once to select STEP DELAY TIME.
19. Press the blue key.
20. Key in the desired STEP DELAY TIME value with the numeric keys. If the unit for STEP DELAY TIME is milliseconds, press the ms key (INTERNAL BIAS key). The ms unit indicator lamp adjacent to the V-t display will light.
21. Press the ENTER key.

Note

START V and STOP V are limited by the setting of the INT BIAS switch, as shown in the following table:



START V and STOP V Range	INT BIAS Switch Setting
+ 42V ~ - 42V	 <p>±100V MAX ±42V MAX</p>
+ 100V ~ - 100V	 <p>±100V MAX ±42V MAX</p>

Figure 3-20. Bias Sweep Set-up Procedure (Sheet 2 of 3)

If a value exceeding the limit set by the INT BIAS switch is entered for START V or STOP V, error code E-8.0 or E-8.1 will appear on the V·t display.

Note

If an error-code is displayed on the V·t display, press the blue key and then re-enter the PARAMETER value correctly.

Note

The START V, STOP V, and STEP V values stored in the 4280A's internal memory, displayed on the front panel, and used during a swept measurement may differ slightly depending on the various voltage ranges used. Refer to the example given in the following

table. Each value stored in memory always has the maximum number of digits possible on the corresponding voltage range. Displayed START V and STOP V values always have the maximum number of digits for the corresponding voltage range. The value used during swept measurements always has the maximum number of digits possible on the voltage range corresponding to the highest of the three values.

	Stored in Memory	V·t Display	Sweep
START V	3.21V	3.2V	3.2V
STOP V	40.0V	40.0V	40.0V
STEP V	1.234V	1.234V	1.2V

Figure 3-20. Bias Sweep Set-up Procedure (Sheet 3 of 3)

3-80. HOLD TIME

3-81. HOLD TIME sets the bias stabilization periods at the beginning and end of bias sweeps made with the internal dc bias source. Settable range is 3ms to 650s. Table 3-14 gives setting resolution.

Table 3-14. HOLD TIME Resolution

HOLD TIME Range	Resolution
3ms ~ 65ms	1ms
70ms ~ 99.99s	10ms
100.0s ~ 650.0s	100ms

3-82. STEP DELAY TIME

3-83. STEP DELAY TIME sets the bias stabilization period for each step of a bias sweep made with the internal dc bias source. Settable range and resolution are identical to those for HOLD TIME.

3-84. C-V MODE MEASUREMENT EXAMPLE

3-85. Figure 3-21 gives the procedure for measuring the C-V characteristics of a floating sample. Figure 3-22 gives the procedure for performing the same measurement under HP-IB control.

Example of C-V Mode Measurement

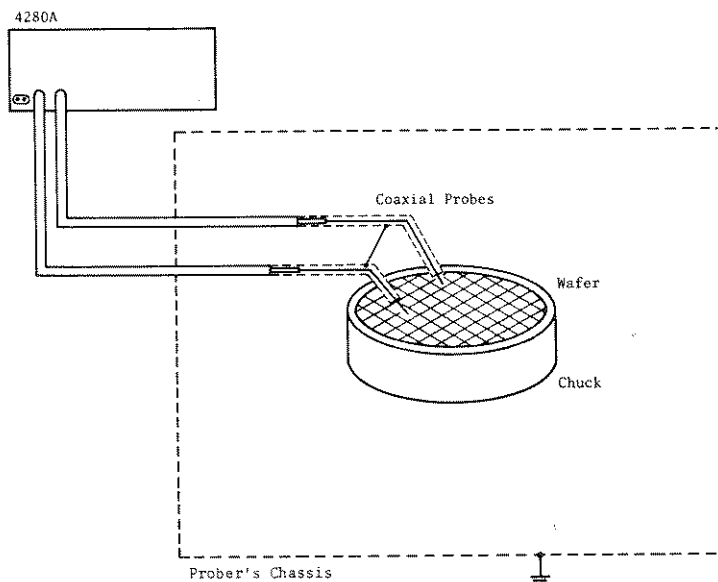

1. Connect the test fixture or test leads to the UNKNOWN terminals.
2. Turn the 4280A on.

Note

When first turned on, the 4280A is automatically set to connection mode CN10 and is ready to measure a floating device. To measure a grounded device, press the GROUND CONNECTION MODE key.

Note

Measurement accuracy, specified in Table 1-1, is guaranteed after the 4280A has been allowed to warm up at least thirty minutes.

3. Set the INTERNAL BIAS to μ^r , set the SWEEP MODE to SINGLE, and enter the bias sweep parameters — START V, STOP V, STEP V, HOLD TIME, STEP DELAY TIME — as described in Figure 3-20.
4. Perform internal or external error correction. Refer to paragraphs 3-41 and 3-56, respectively.
5. Connect the device to be tested.

6. Press the SWEEP/V OUTPUT (gold-colored) key to start the bias sweep measurement. The red V OUTPUT lamp will light and the START V value will appear on the V·t display. C and G displays will display -----.
7. Capacitance and conductance values measured at the bias voltage displayed on the V·t display are displayed on the C and G displays, respectively, until the next measurement at the next bias voltage is completed.
8. The red V OUTPUT lamp will go off after the last measurement (at the STOP V bias voltage) is completed.
9. Remove the device.

Note

To record measured data, use one of the following:

- (1) X-Y recorder (refer to paragraph 3-156)
- (2) Printer that has a listen only HP-IB capability (refer to paragraph 3-176)
- (3) HP-IB system (see Figure 3-22)

Figure 3-21. C-V Mode Measurement Example (Sheet 1 of 2)

Note

Depending on the specified START V, STOP V, and STEP V values, the last step of a bias sweep may be different from the specified STEP V value. For example, if START V = 0V, STOP V = +5V, and STEP V = 2V, output from the internal dc bias source will be swept as shown below when the SWEEP/V OUTPUT START/STOP key is pressed.

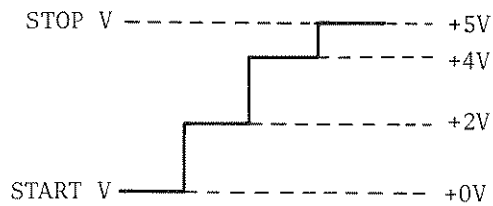
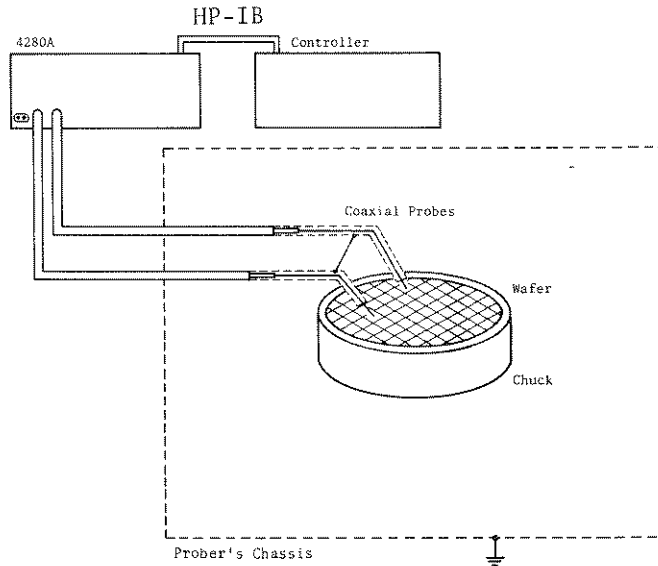

Figure 3-21. C-V Mode Measurement Example (Sheet 2 of 2)

Example of HP-IB Controlled C-V Mode Measurement



1. Interconnect the 4280A and controller with an HP-IB cable.
2. Turn on the 4280A and controller.
3. Load the sample program listed in Figure 3-42.
4. Connect the device to be tested.
5. Run the program. Measurement results will be displayed on the controller's CRT.

Programming Hints

There are three ways to read measurement data. The selection depends on the specified STEP DELAY TIME, data transfer (interfacing) speed, and the printing speed of the printer (if used).

- ① STEP DELAY TIME is long enough for data to be read and then printed.
- ② STEP DELAY TIME is long enough for data to be read; printing, however, cannot be performed.
- ③ STEP DELAY TIME is not long enough for data to be read.

There are three methods to determine the "last data" condition in standard data transfer mode (① and ② above). In block data transfer mode, the data ready bit of the status byte is set when the last measurement is completed.

- 1) Read the V data. For single staircase sweep (f^{f}), "last data" occurs when V data equals STOP V; for a double staircase sweep ($\text{f}^{\text{f}}\text{L}$), "last data" occurs when V data equals START V.

- 2) Count the number of measurement points. "Last data" occurs when the number of measurement points is equal to

$$\frac{(\text{STOP V}) - (\text{START V})}{(\text{STEP V})}$$

for a single staircase sweep (f^{f}), or

$$2 \times \frac{(\text{STOP V}) - (\text{START V})}{(\text{STEP V})}$$

for a double staircase sweep ($\text{f}^{\text{f}}\text{L}$).

- 3) Read the status data in BINARY format (refer to paragraph 3-190). Bit 6 is set when "last data" occurs.

For details, refer to Figure 3-42.

Figure 3-22. HP-IB Controlled C-V Mode Measurement Example (Sheet 1 of 2)

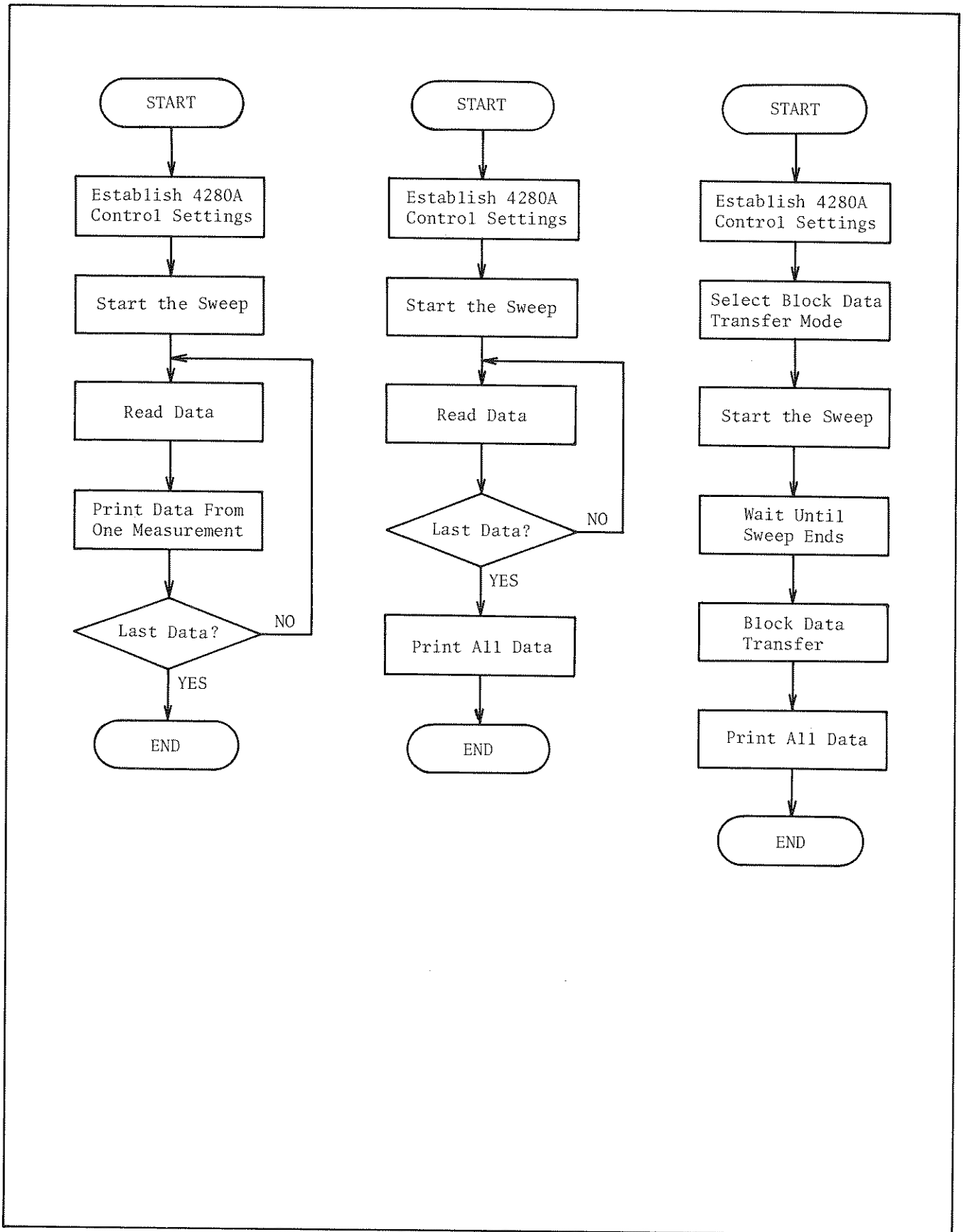

Figure 3-22. HP-IB Controlled C-V Mode Measurement Example (Sheet 2 of 2)



C-t MODE

3-86. C-t MODE

3-87. When set to C-t mode, the 4280A applies a bias pulse to the device under test and then measures capacitance and conductance at a constant time interval. The bias pulse width (t_h) and the measurement interval (t_d) are user-selectable over the range of 10ms to 32s. If an external pulse bias source is used, however, the lower limit for t_h and t_d is 10 μ s. Paragraphs 3-88 through 3-155 describe instrument operations and functions that are unique to C-t mode operation. Information concerning basic operations is covered in paragraphs 3-1 through 3-57. The procedure for setting the 4280A to C-t mode is given below.

1. Turn the 4280A on.
2. Press the blue key.
3. Press one of the FUNCTION keys—C·G, C, or G. The lamp at the center of the key will flash off and on.

Once C-t mode is set, it is not necessary to press the blue key to select another measurement function. Simply press the desired function key. To exit C-t mode, press the blue key and then press the FUNCTION key whose indicator lamp is flashing.

Note

MEAS SPEED SLOW cannot be selected when the 4280A is in C-t mode.

Note

In C-t mode, AUTO ranging is performed only for the first measurement of a C·G-t, C-t, or G-t measurement. All subsequent measurements are made on the range selected at the first measurement point. If the measured value at a later measurement point is larger than that of the first measurement point, a measurement overflow may occur. To prevent this, manually select the appropriate range before starting the measurement.

Note

During a C-t mode (BURST integration mode) measurement, if a front panel key is pressed or a range change occurs, the microprocessor may not be able to control the measurement circuits with the correct timing, and error code E-11.2 may appear. To avoid this do not operate any switches or keys, and use MANUAL ranging mode. If the 4280A is operated via the HP-IB, do not read the 4280A's status byte using serial polling, and do not read the measurement data at each measurement point. Use block data transfer mode.

3-88. C-t PARAMETERS

3-89. To perform a C-t measurement, five parameters—PULSE V, MEAS V, NO OF READINGS, t_h (PULSE V width), and t_d (measurement interval)—must first be set. These parameters are described in paragraphs 3-90 through 3-99. Figure 3-23 shows the timing diagram of a C-t measurement and gives the procedure for setting the C-t parameters.

3-90. PULSE V

3-91. PULSE V (pulse voltage) sets the amplitude of the bias pulse supplied from the internal dc bias source. Settable range is 0V to ± 100 V. Resolution is given in Table 3-15. If the specified PULSE V and MEAS V (paragraph 3-92) values have different resolution, the parameter with the higher (more sensitive) resolution will be rounded to suit the lower (less sensitive) resolution of the other parameter.

Table 3-15. PULSE V Resolution

PULSE V Range	Resolution
$\pm (0.000 \sim 1.999) V$	1mV
$\pm (2.00 \sim 19.99) V$	10mV
$\pm (20.0 \sim 100.0) V$	100mV

3-92. MEAS V

3-93. MEAS V (measurement voltage) sets the bias voltage to be applied to the device under test during measurement. Settable range and resolution are the same as those of PULSE V. Refer to Table 3-15. If the specified PULSE V and MEAS V values have different resolution, the parameter with the higher (more sensitive) resolution will be automatically rounded to suit the lower (less sensitive) resolution of the other parameter.

Note

When PULSE V or MEAS V values greater than $\pm 42V$ are used, be sure to set the INT BIAS switch to the $\pm 100V$ MAX position.

3-94. NO OF READINGS

3-95. NO OF READINGS (number of readings) sets the total number of measurements that will be made after the bias pulse period. Settable range is 1 to 9999.

3-96. th

3-97. th (hold time) sets the width of the bias pulse (PULSE V). Settable range is $10\mu s$ to 32s. Resolution is given in Table 3-16.

Table 3-16. th Resolution

th Range	Resolution
$10\mu s \leq th \leq 65 ms$	$10\mu s$
$65 ms < th < 1 s$	$500\mu s$
$1 s \leq th < 10 s$	1 ms
$10 s \leq th \leq 32 s$	10 ms

Note

When a th value outside allowable resolution is set, it is automatically rounded. Refer to the following examples.

Entered th Value	Set Value
$.99925s \leq th < .99975s$	999.5ms
$.99975s \leq th < 1.0005s$	1.000s

3-98. td

3-99. td (delay time) sets the measurement interval. Settable range is $10\mu s$ to 32s. Resolution is the same as that of th. Refer to Table 3-16. It is important to note that measurement interval, td, is the time from the mid-point of one measurement period to the mid-point of the succeeding measurement period. It is not the time between successive measurement periods.

3-100. PULSE BIAS SOURCE

3-101. The bias pulse required for C-t mode measurements can be supplied either from the 4280A's own internal dc bias source or from an external pulse generator connected to the rear panel of the 4280A. Bias pulses supplied from the internal dc bias source can be used only when the bias current does not exceed $\pm 6mA$ and the device being measured has a relatively slow transient capacitance characteristic. However, no external equipment is required. For devices that exhibit quick response curves, an external pulse generator is best. Complete synchronization between the 4280A and the pulse generator is easily accomplished. Refer to paragraph 3-126. The table below lists the pulse bias source recommended for various ranges of measurement interval (td) values.

td Range	Pulse Bias Source
$10\mu s$ to 32s	External FAST
$200\mu s$ to 32s	External SLOW
$250ms^*$ to 32s	Internal

* When C or G function is selected and FAST measurement speed is used, td down to 150ms (local operation) or down to 10ms (HP-IB block data transfer mode) can be used. Refer to paragraph 3-110.

3-102. CONNECTION MODE SELECTION

3-103. The connection mode used for a C-t mode measurement must be selected according to the type of measurement — Floating or Grounded — and biasing method. Refer to Table 3-17.

Table 3-17. Connection Mode Selection

Pulse Bias Source	Floating	Grounded	
	HIGH-LOW	HIGH-GND	LOW-GND
Internal	CN10	CN15	CN20
Ext. SLOW	CN12	CN17	CN19
Ext. FAST	CN13, CN14		

3-104. DC OFFSET FOR PULSED BIASING

3-105. When performing a floating measurement with bias pulses output from the UNKNOWN HIGH terminal, a dc offset voltage can be output from the UNKNOWN LOW terminal. This application is useful when the external pulse generator does not have dc offset capability. For details refer to paragraphs 3-112 and 3-128.

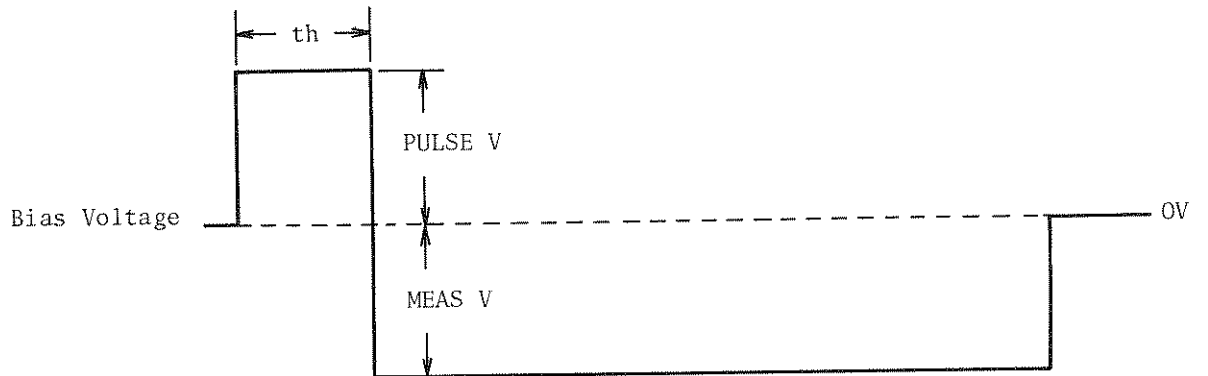

t_h = Pulse Width
 t_d = Measurement Interval
 t = Measurement Time

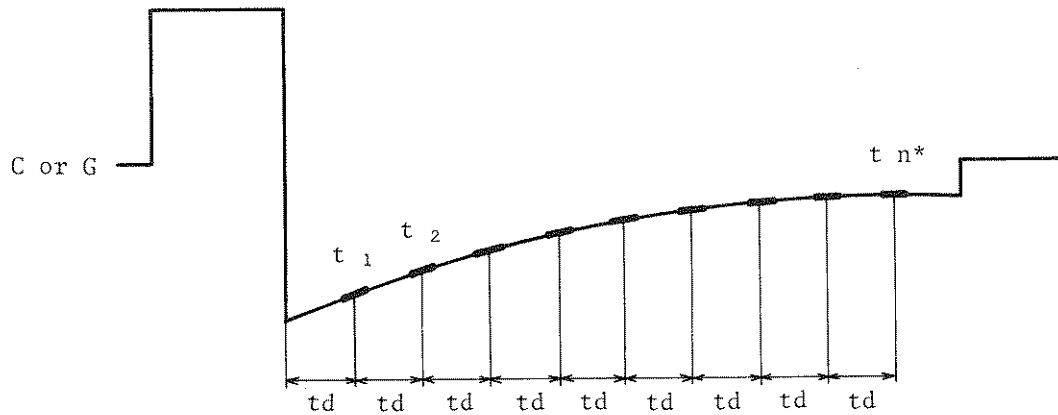

*n subscript is NO OF READINGS.

Figure 3-23. Procedure for Setting C-t Mode Parameters (Sheet 1 of 3)

C-t Mode Parameter Setting

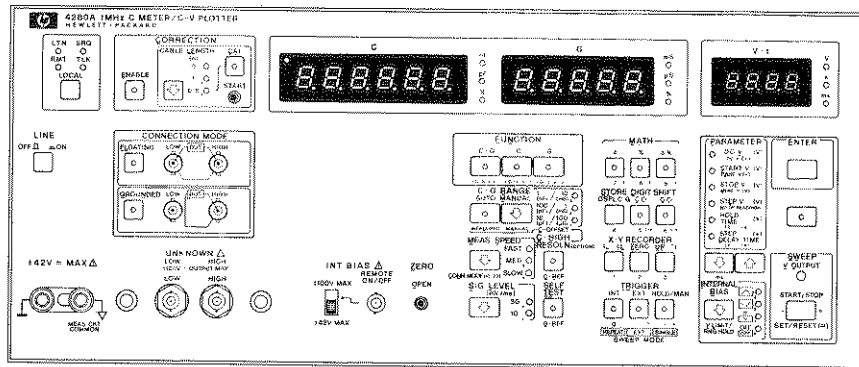

The procedure for setting the various parameters--PULSE V, MEAS V, NO OF READINGS, bias pulse width (th), and measurement interval (td)--required to perform a C-t measurement using the internal dc bias source is given below.

1. Turn the 4280A on.
2. Press the blue key. The lamp at the center of the key will light.
3. Press the desired FUNCTION key--C-G, C, or G. The lamp at the center of the key will flash off and on, indicating that the 4280A is in C-t mode.

[PULSE V Setting]

4. Select PULSE V with the \square or \square PARAMETER key.
5. Press the blue key. The existing PULSE V value will appear on the V-t display.
6. Key in the desired PULSE V value with the numeric keys. The new value will appear on the V-t display as it is keyed in.
7. Press the ENTER key.

[MEAS V Setting]

8. Select MEAS V by pressing the \square PARAMETER key once.
9. Press the blue key. The existing MEAS V value will appear on the V-t display.

10. Key in the desired MEAS V value with the numeric keys. The new value will appear on the V-t display as it is keyed in.

11. Press the ENTER key.

[NO OF READINGS]

12. Select NO OF READINGS by pressing the \square PARAMETER key once.
13. Press the blue key. The existing NO OF READINGS value will appear on the V-t display.
14. Key in the desired NO OF READINGS value with the numeric keys. The new value will appear on the V-t display as it is keyed in.

15. Press the ENTER key.

[th Setting]

16. Select th by pressing the \square PARAMETER key once.
17. Press the blue key. The existing th value will appear on the V-t display.
18. Key in the desired th value with the numeric keys. The new value will appear on the V-t display. If the unit of the displayed value is to be ms, press the INTERNAL BIAS key.

19. Press the ENTER key.

Figure 3-23. Procedure for Setting C-t Mode Parameters (Sheet 2 of 3)

<p>[td Setting]</p> <ol style="list-style-type: none"> 20. Select td by pressing the <input type="checkbox"/> PARAMETER key once. 21. Press the blue key. The existing td value will appear on the V•t display. 22. Key in the desired td value with the numeric keys. The new value will appear on the V•t display. If the unit of the displayed value is to be ms, press the INTERNAL BIAS key. 23. Press the ENTER key. 	<p style="text-align: center;">Note</p> <p>For external pulse-biased C-t mode measurements the INTERNAL BIAS should be set to OFF or ==, and PULSE V and MEAS V cannot be entered. Only DC V (only when == is selected), th, td, and NO OF READINGS need to be set. PULSE V and MEAS V are set by the external pulse bias source. The procedure for setting DC V is as follows.</p>
<p style="text-align: center;">Note</p> <p>If a voltage or time exceeding prescribed limits is entered, an error code will appear on the V•t display.</p>	<p>[DC V Setting]</p> <ol style="list-style-type: none"> 1. Select DC V with the <input type="checkbox"/> or <input type="checkbox"/> PARAMETER key. 2. Press the blue key. 3. Key in the desired DC V value with the numeric keys. 4. Press the ENTER key.

Figure 3-23. Procedure for Setting C-t Mode Parameters (Sheet 3 of 3)

Internal Pulse Biasing

3-106. C-t MODE MEASUREMENT WITH INTERNALLY SUPPLIED BIAS PULSE

3-107. To perform a C-t mode measurement using the internal dc bias source as the bias pulse source, set the 4280A to C-t mode (refer to Figure 3-4) and set INTERNAL BIAS to Γ . Set the PULSE V, MEAS V, NO OF READINGS, th and td parameters as appropriate for the measurement.

Note

The following table lists the recommended connection modes.

Floating	Grounded	
HIGH-LOW	HIGH-GND	LOW-GND
CN10	CN15	CN20

3-108. th (PULSE BIAS WIDTH) SETTING RANGE

3-109. The width of the bias pulse (PULSE V) is determined by the specified th value. The settable range for th is 10ms to 32s. Table 3-16 lists the setting resolution for th.

3-110. td (MEASUREMENT INTERVAL) SETTING RANGE

3-111. The settable range for td (measurement interval) depends on several factors: measurement function, measurement speed, and, when under remote control via the HP-IB, data transfer mode and output data format. Table 3-19 lists the settable ranges for td when a C-t mode measurement is made using the internal pulse bias source.

3-112. EXTERNAL DC OFFSET OF INTERNALLY SUPPLIED PULSE BIAS VOLTAGE

3-113. An external dc bias source can be used to provide offset voltage for internally biased C-t mode measurements. Offset voltage supplied in this way must not exceed $\pm 42V$, and maximum allowable current is $\pm 6mA$. The external dc bias source must be connected to the EXT BIAS SLOW BNC connector on the rear panel of the 4280A. This application can be used in connection mode CN11.

3-114. EXAMPLE OF INTERNALLY BIASED C-t MODE MEASUREMENT

3-115. Figure 3-25 gives the procedure for making a C-t mode measurement on a floating device. Figure 3-26 gives additional information on performing the same measurement under HP-IB control.

Table 3-19. td Setting Range (Internal Pulse Bias)

Data Transfer	Output Data Format	FUNCTION	MEAS SPEED	
			FAST	MED
Standard Mode	ASCII Output	C G-t	200ms to 32s	250ms to 32s
		C-t, G-t	150ms to 32s	200ms to 32s
	BINARY Output	C G-t	50ms to 32s	100ms to 32s
		C-t, G-t	20ms to 32s	50ms to 32s
Block Mode	ASCII Output or BINARY Output	C G-t	50ms to 32s	100ms to 32s
		C-t, G-t	10ms to 32s	50ms to 32s

Example of Internal Pulse Bias C-t Measurement

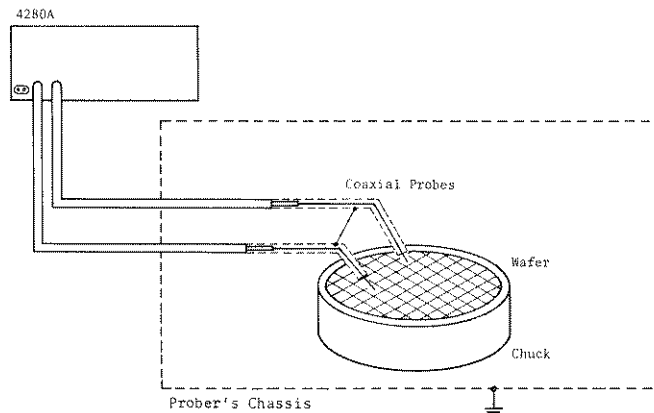

1. Connect the test fixture or test leads to the UNKNOWN terminals.
2. Turn the 4280A on.

Note

Measurement accuracy, specified in Table 1-1, is guaranteed after the 4280A has been allowed to warm up at least thirty minutes.

3. Set the 4280A to C-t mode. INTERNAL BIAS mode will be automatically set to Γ . (Refer to Figure 3-4.)
4. Set the C-t mode parameters -- PULSE V, MEAS V, NO OF READINGS, t_b (bias pulse width), and t_d (measurement interval) -- as described in Figure 3-23. Set SWEEP MODE to SINGLE.
5. Perform internal or external error correction as described in paragraphs 3-41 and 3-56, respectively.
6. connect the device to be tested.
7. Press the SWEEP/V OUTPUT key to start the measurement. The red V OUTPUT lamp will light and the time of the first measurement will be displayed on the V·t display. The C and G displays will display-----.

8. Capacitance and conductance values measured at the time displayed on the V·t display will appear on the C and G displays, respectively, and will remain until the next measurement is completed.
9. The red V OUTPUT lamp will go off after the specified NO OF READINGS have been taken.
10. Remove the test device.

Note

An X-Y recorder or a listen only printer can be used only when t_d is relatively long. Block data transfer mode is recommended for C-t mode measurements. Refer to paragraph 3-194.

Figure 3-25. Internal Pulse Bias C-t Mode Measurement Example

Example of HP-IB Controlled Internal Pulse Bias C-t Measurement

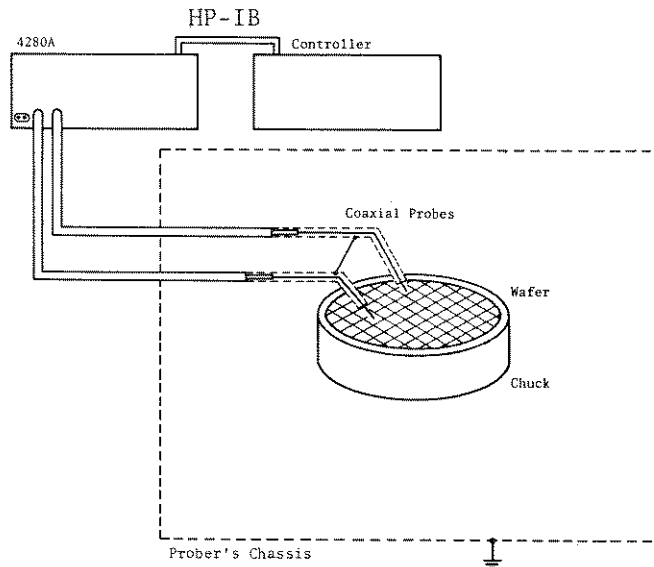

1. Turn off the 4280A and controller, and then interconnect both with an HP-IB cable.
2. Turn the 4280A and controller on.
3. Load one of the sample programs listed in Figure 3-42.
4. Connect the device to be tested.
5. Run the sample program. Measurement results will be printed out.

Note

Refer to Figure 3-42 for details on sample programs.

Figure 3-26. HP-IB Controlled Internal Pulse Bias C-t Mode Measurement Example

External Pulse Biasing

3-116. C-t MODE MEASUREMENT USING EXTERNALLY SUPPLIED BIAS PULSE

3-117. The bias pulse required for a C-t mode measurement can be supplied either from the 4280A's internal dc bias source or from an external pulse generator connected to the rear panel of the 4280A. Internally supplied pulse biasing is suitable for devices having slow to medium transient response. To measure devices that have fast response, though, externally supplied pulse biasing is preferable. The 4280A can perform either SLOW or FAST C-t mode measurements using externally supplied pulse biasing. The choice depends on the characteristics of the device being measured and on the measurement objectives. SLOW C-t mode measurement provides better accuracy than that of a FAST C-t mode measurement. The latter, however, provides optimum speed. Table 3-20 lists the connection modes that can be used for each type of measurement.

Table 3-20. Connection Modes for SLOW and FAST C-t Mode Measurements

External Bias	Floating	Grounded	
	HIGH-LOW	HIGH-GND	LOW-GND
SLOW	CN12	CN17	CN19
FAST	CN13, CN14		

3-118. MEASUREMENT INTEGRATION MODE

3-119. Two modes of integration are available for externally biased C-t mode measurements: BURST and SAMPLING. In BURST integration mode, the 4280A makes one measurement per measurement point. In SAMPLING integration mode, however, it repeats several partial measurements at each measurement point. Figures 3-27 and 3-28 show BURST and SAMPLING integration modes, respectively. The integration mode is automatically selected depending on the FUNCTION, CONNECTION MODE, MEAS SPEED, and t_d (measurement interval). Refer to Tables 3-25 and 3-28.

Note

If t_d is shorter than 5s, measurement integration mode can be set via the HP-IB.

3-120. BURST INTEGRATION MODE

3-121. In BURST integration mode, the instrument applies one bias pulse to the device under test, and then makes the specified number of measurements (NO OF READINGS) at the specified measurement interval (t_d). Figure 3-27 shows this. BURST integration mode results when t_d is much longer than the 4280A's measurement time.

3-122. SAMPLING INTEGRATION MODE

3-123. In SAMPLING integration mode, the 4280A makes a number of sample-and-hold-type measurements at each measurement point. The 4280A applies a bias pulse to the device under test, and then makes a very short measurement, allowing the integrator inside the 4280A to charge for only a fraction of the usual time. The charge is held and another bias pulse is applied to the device under test. A second short measurement is made and the integrator charges a little more. This process is repeated until the cumulative charge times equal the normal integration charge period. Refer to Figure 3-28. The number of samples per measurement depends on the t_d value multiplied by k , which is an ordinal number representing a given measurement point — 1, 2, 3, ..., NO OF READINGS. SAMPLING integration mode allows C-t mode measurements with measurement intervals as short as 10 μ s.

Note

In SAMPLING integration mode, the following conditions must be satisfied.

- (1) $t_d \times N \leq 5s$
where t_d is the measurement interval and N is NO OF READINGS.

(2)

FUNCTION	MEAS SPEED	
	FAST	MED
C·G-t	$th \leq 500 \cdot t_d$	$th \leq 100 \cdot t_d$
C-t, G-t	$th \leq 500 \cdot t_d$	$th \leq 200 \cdot t_d$

t_d : Pulse Width

3-124. USING AN EXTERNAL PULSE GENERATOR FOR PULSE BIASING

3-125. To use an external pulse generator (the HP 8112A, for example) to supply the bias pulses necessary for C-t mode measurements, interconnect the 4280A and pulse generator as shown in Figure 3-29. Pulse height, measurement dc bias voltage, and pulse width are controlled by the pulse generator. Depending on the connection mode, the internal dc bias source can be used in conjunction with an external pulse generator. Refer to paragraph 3-128. The 4280A provides a SYNC OUTPUT signal to synchronize the pulse generator with the measurement. SYNC OUTPUT also controls the bias pulse width. To use this feature, you must set the pulse generator to EXT WIDTH (E. WID on the HP 8112A) operating mode. Refer to paragraph 3-126.

3-126. SYNC OUTPUT

3-127. The SYNC OUTPUT connector on the rear panel of the 4280A outputs a TTL level signal at the start of C-t mode measurements. The duration of the pulse is equal to the t_h (pulse width) setting. This signal is used to synchronize the bias pulses supplied from an external pulse generator with the measurement. This signal is available only when the 4280A is set to C-t mode and when the internal dc bias source is not set to \lfloor (pulse). Figure 3-30 shows the SYNC OUTPUT signal.

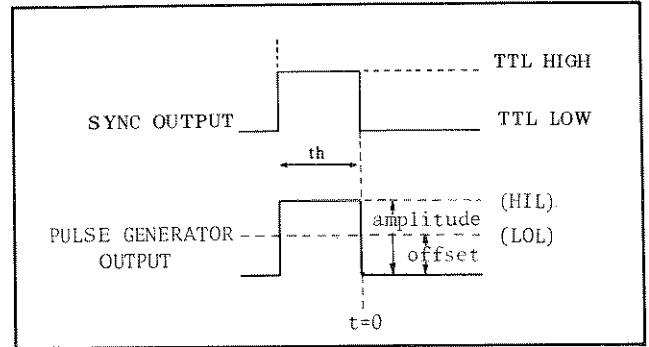

Figure 3-30. Pulse Generator Output Controlled by SYNC OUTPUT Signal

3-128. DC OFFSET OF EXTERNALLY SUPPLIED PULSE BIAS VOLTAGE

3-129. Pulse bias voltage supplied from an external pulse generator can be offset using the internal dc bias source or another external source. See Table 3-22. For details on dc offset, refer to paragraphs 3-132, 3-145 and 3-147. This feature can be used only when the 4280A is set to floating connection mode.

Table 3-22. DC Offset of External Pulse Voltage

Pulse Bias Source	Connection Mode	DC Bias Source
Ext. SLOW	CN12	Internal
Ext. FAST	CN13	Internal
	CN14	External

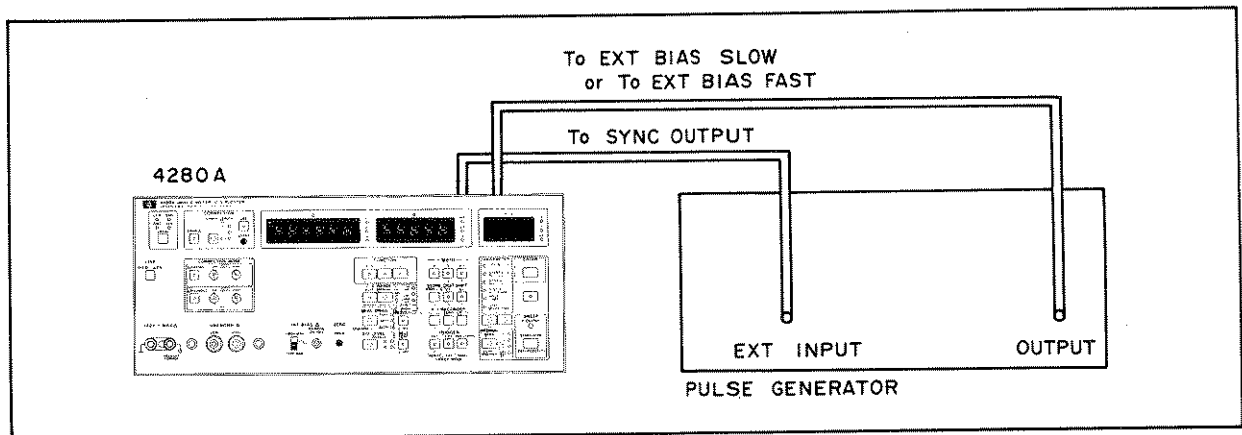

Figure 3-29. External Pulse Generator Connection

BURST Integration Mode

In BURST integration mode, the 4280A applies one bias pulse to the device under test and then makes the specified number of measurements (NO OF READINGS) at the specified measurement interval (t_d). Figure A below shows one measurement point of a C-t mode measurement made in BURST integration mode. Figure B shows the entire measurement.

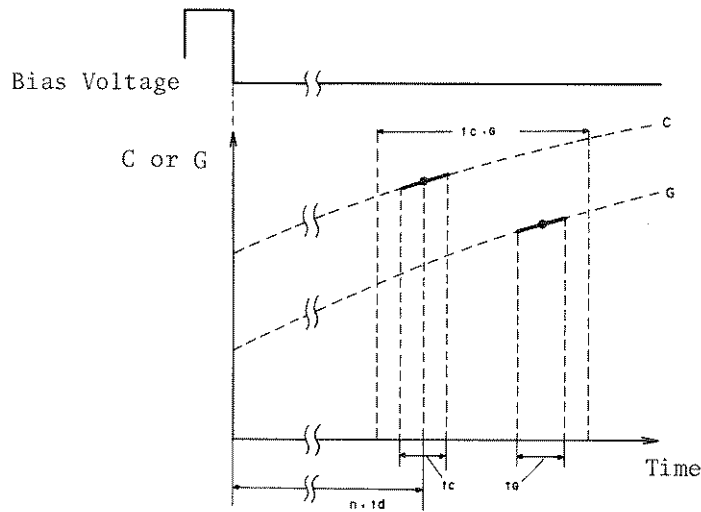

Figure A

$t_{c,g}$: Measurement Time
 t_c, t_g : Integration Time

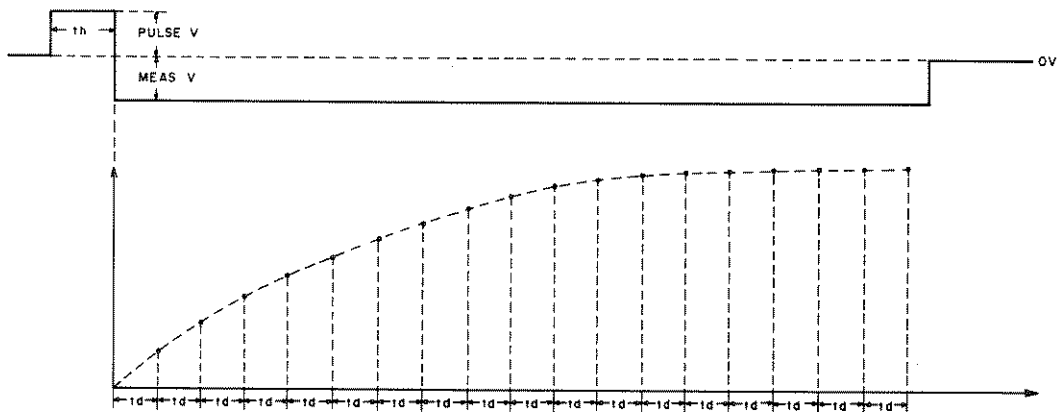

Figure B

Figure 3-27. BURST Integration Mode

SAMPLING Integration Mode

In SAMPLING integration mode, the 4280A makes a number of sample-and-hold-type measurements at each measurement point. Figure A below shows a portion of a C-t mode measurement made in SAMPLING integration mode. Figure B shows the entire measurement.

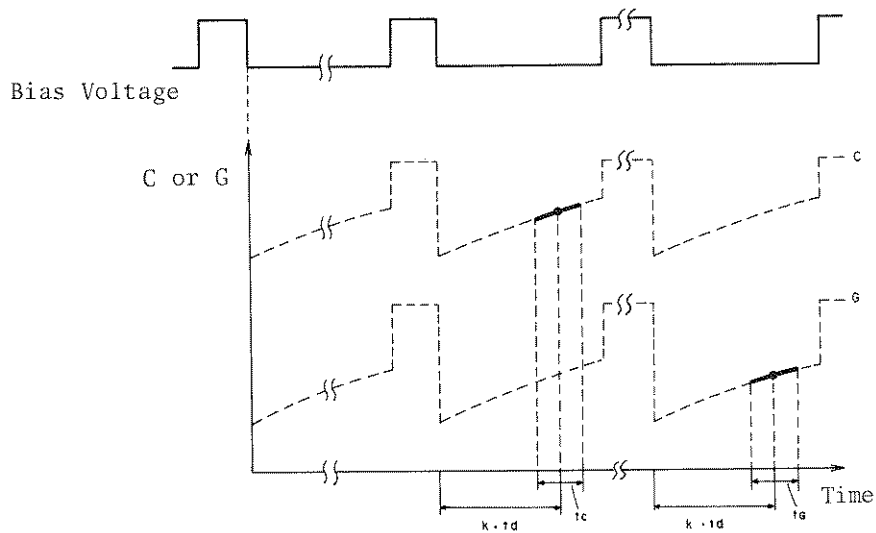

Figure A

t_c, t_g : Integration Time

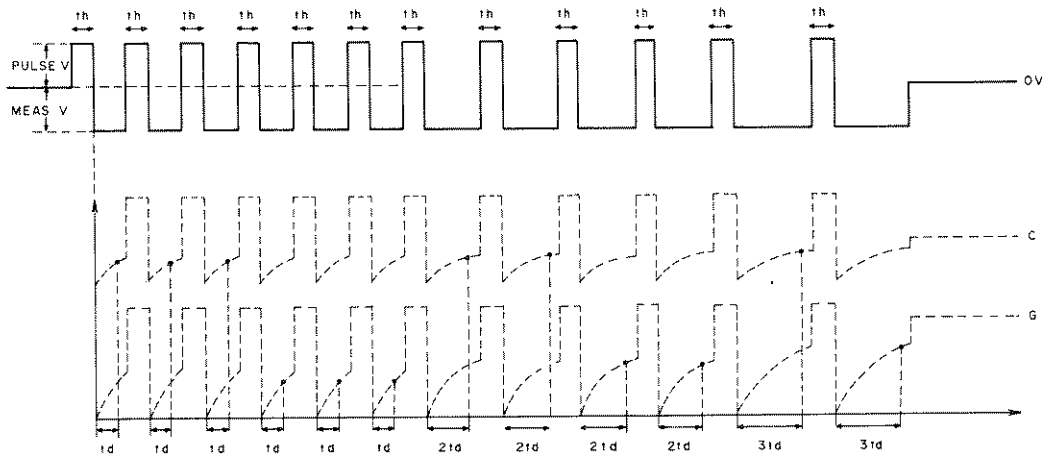

Figure B

Figure 3-28. SAMPLING Integration Mode

3-130. EXTERNAL PULSE BIAS SLOW C-t MEASUREMENT

3-131. To set up an external bias SLOW C-t mode measurement, (1) set the 4280A to C-t mode (refer to Figure 3-4), (2) select the desired connection mode (refer to the table below), and (3) set the INTERNAL BIAS to OFF.

Floating	Grounded	
HIGH-LOW	HIGH-GND	LOW-GND
CN12	CN17	CN19

3-132. DC BIAS OFFSET FOR SLOW C-t MEASUREMENTS

3-133. The internal dc bias source can be used as a dc offset source. However, bias current should not exceed $\pm 6\text{mA}$ and a floating connection mode should be used. To offset the pulse bias, set the INTERNAL BIAS to \equiv and set the DC V parameter as appropriate.

3-134. BIAS-PULSE WIDTH (th) SETTABLE RANGE (SLOW C-t)

3-135. For an external pulse bias SLOW C-t mode measurement, the settable range for the bias-pulse width depends on integration mode. Refer to Table 3-23.

Table 3-23. Bias-Pulse Width (th) Settable Range (SLOW C-t)

Integration Mode	th Range
SAMPLING Mode	$50\ \mu\text{s} \leq \text{th} \leq 5\text{s}$
BURST Mode	$50\ \mu\text{s} \leq \text{th} \leq 32\text{s}$

Note

In SAMPLING integration mode, bias-pulse width (th) is also limited by measurement interval (td). Refer to paragraph 3-122.

3-136. MEASUREMENT INTERVAL (td) SETTABLE RANGE (SLOW C-t)

3-137. For an external pulse bias SLOW C-t mode measurement, the settable range for the measurement interval (td) depends on integration mode, measurement function, and data transfer mode. Refer to Table 3-25. For local operation use the shaded area of the table.

3-139. EXTERNAL PULSE BIAS SLOW C-t MEASUREMENT EXAMPLE

3-140. Figure 3-31 gives the procedure for performing an external pulse bias SLOW C-t measurement on a floating device. Figure 3-32 gives additional information for performing the same measurement under remote control via the HP-IB.

Table 3-25. Measurement Interval (td) Settable Range (SLOW C-t)

Data Transfer Mode	Output Data Format	Function	MEAS SPEED	Measurement Interval (td) Settable Range							
				200µs~	10ms~	20ms~	50ms~	100ms~	150ms~	200ms~	250ms ~ 32s
Standard Data Transfer Mode	ASCII	C·G-t	FAST	SAMPLING					BURST		
			MED	SAMPLING					BURST		
		C-t or G-t	FAST	SAMPLING					BURST		
			MED	SAMPLING					BURST		
	Binary	C·G-t	FAST	SAMPLING			BURST				
			MED	SAMPLING				BURST			
		C-t or G-t	FAST	SAMPLING		BURST					
			MED	SAMPLING			BURST				
Block Data Transfer Mode	ASCII	C·G-t	FAST	SAMPLING			BURST				
			MED	SAMPLING				BURST			
	Binary	C-t or G-t	FAST	SAMPLING	BURST						
			MED	SAMPLING			BURST				

* If td is shorter than 5s, SAMPLING integration mode can be selected by using remote program code "SA1." For local operation, use the shaded area of the table.

Example of External Pulse Bias SLOW C-t Measurement

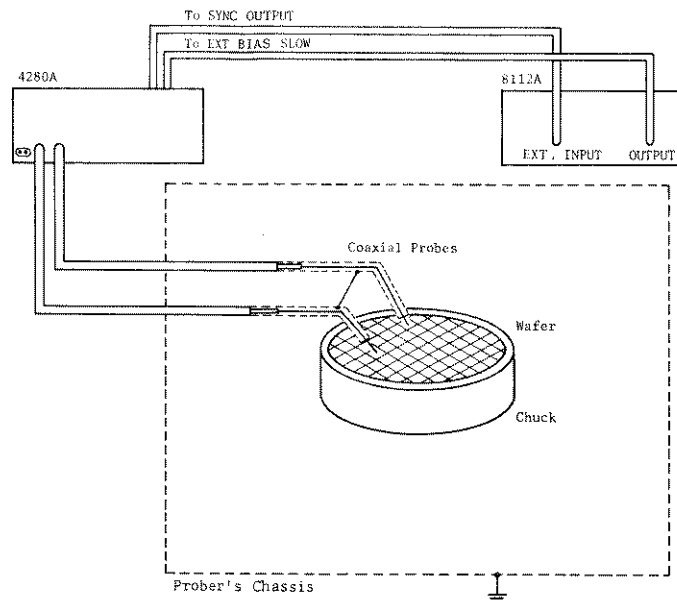

1. Interconnect the 4280A and pulse generator (HP 8112A or equivalent) as shown above.
2. Connect the test fixture or test leads to the UNKNOWN terminals.
3. Turn on the 4280A and the pulse generator. Keep the pulse generator's output disabled.
4. Set the 4280A to C-t mode. Set other controls as follows.

Connection Mode.....	CN12
INTERNAL BIAS.....	OFF
SWEEP MODE.....	SINGLE
5. Set the pulse generator to EXT WIDTH (E.WID on the 8112A) mode, and adjust the EXT INPUT's threshold to the proper TTL level (SYNC OUTPUT signal of the 4280A).
6. Set NO OF READINGS and th on the 4280A, and set the pulse HIGHT and OFFSET voltage (HIL and LOL, respectively, on the 8112A) on the pulse generator.
7. Enable the pulse generator.
8. Perform internal or external error correction as described in paragraph 3-41 and 3-56, respectively.
9. Connect the device to be tested.
10. Press the SWEEP/V OUTPUT key to start the measurement. The red V OUTPUT lamp will light and the time of the first measurement will be displayed on the V·t display. C and G displays will display -----.
11. Capacitance and conductance values measured at the time displayed on the V·t display will appear on the C and G displays, respectively, and will remain until the next measurement is completed.
12. The red V OUTPUT lamp will go off after the specified NO OF READINGS have been taken.
13. Remove the test device.

Note

An X-Y recorder and a listen only printer can be used only when td is relatively long. Block data transfer mode is recommended for C-t mode measurements. Refer to paragraph 3-194.

Figure 3-31. External Pulse Bias SLOW C-t Measurement Example

Example of HP-IB Controlled External Pulse Bias SLOW C-t Measurement

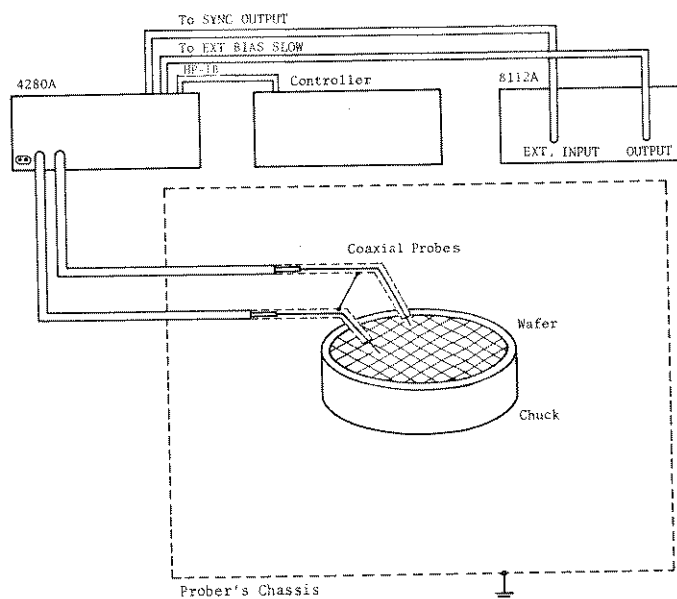

1. Interconnect the 4280A and, if necessary, the pulse generator to the controller using HP-IB cables.
2. Interconnect the 4280A and the pulse generator as shown above.
3. Turn on the 4280A, pulse generator, and controller.
4. Load one of the sample programs listed in Figure 3-42. (The sample programs in Figure 3-42 do not control the pulse generator.)
5. Set the pulse generator to EXT WIDTH mode, and adjust EXT INPUT threshold to the proper TTL level.
6. Connect the device to be tested.
7. Run the program. Measurement results will be displayed on the controller's CRT.

Figure 3-32. HP-IB Controlled External Pulse Bias SLOW C-t Measurement Example

3-141. EXTERNAL PULSE BIAS FAST C-t MEASUREMENT

3-142. To set up an external bias FAST C-t mode measurement, (1) set the 4280A to C-t mode (refer to Figure 3-4) and (2) select the desired connection mode and INTERNAL BIAS mode (refer to paragraph 3-143).

Note

The output impedance of the pulse generator (includes the impedance of the cable that connects the 4280A's EXT BIAS FAST connector to the pulse generator's output terminal) should be $50\Omega \pm 1\%$. If not, measurement accuracy listed in Table 1-1 will not be possible.

Note

External bias FAST C-t mode can be used for measuring floating devices only.

3-143. CONNECTION MODES AND INTERNAL BIAS MODE SELECTION FOR FAST C-t MEASUREMENT

3-144. Only connection modes CN13 and CN14 can be used for external bias FAST C-t mode measurements. The choice of connection mode depends on the dc offset voltage requirements. Refer to the following table.

Connection Mode	INTERNAL BIAS	DC Offset
CN13	OFF	DC offset is not required.
	==	DC offset is required and bias current does not exceed $\pm 6\text{mA}$.
CN14	OFF	DC offset is required (supplied from an external source connected to the EXT BIAS SLOW terminal) and bias current will exceed $\pm 6\text{mA}$.

3-147. DC BIAS OFFSET FOR FAST C-t MEASUREMENTS

3-148. Either the internal dc bias source or an external dc bias source connected to the EXT BIAS SLOW connector can be used for dc bias offset.

If the bias current will not exceed $\pm 6\text{mA}$, the internal dc bias source can be used. Select connection mode CN13 and set the INTERNAL BIAS mode to ==. Enter desired offset voltage value as DC V.

If the bias current will exceed $\pm 6\text{mA}$, an external dc bias source should be used. Select connection mode CN14 (INTERNAL BIAS mode will be set to OFF automatically). Connect the external dc bias source to the EXT BIAS SLOW connector on the 4280A's rear panel. Maximum allowable external bias voltage is $\pm 42\text{V}$ and current is $\pm 100\text{mA}$.

Note

If the output impedance of the external dc bias source is too low, measurement results may fluctuate considerably from one measurement point to the next due to the bias circuit's resonating with the bias pulse. To prevent this, insert a low value resistor (a few ohms or so) in series with the dc bias circuit.

3-149. BIAS PULSE WIDTH (th) SETTABLE RANGE (FAST C-t)

3-150. For an external pulse bias FAST C-t mode measurement, the settable range for the bias-pulse width depends on the integration mode. Refer to Table 3-26.

Table 3-26. Bias-Pulse Width (th) Settable Range (FAST C-t)

Integration Mode	th Range
BURST Mode	$10\mu\text{s} \leq \text{th} \leq 32\text{s}$
SAMPLING Mode	$10\mu\text{s} \leq \text{th} \leq 5\text{s}$

Note

In SAMPLING Mode, bias-pulse width (th) is also limited by measurement interval (td). Refer to paragraph 3-122.

3-151. MEASUREMENT INTERVAL (td) SETTABLE RANGE (FAST C-t)

3-152. For an external pulse bias FAST C-t mode measurement, the settable range for the measurement interval (td) depends on the integration mode, measurement speed, measurement function, and data transfer mode. Refer to Table 3-28. For local operation (non-HP-IB control), use the shaded area of the table.

3-154. EXTERNAL PULSE BIAS FAST C-t MEASUREMENT EXAMPLE

3-155. Figure 3-33 gives the procedure for performing an external pulse bias FAST C-t measurement on a floating device. Figure 3-34 gives additional information for performing the same measurement under remote control via the HP-IB.

Table 3-28. Measurement Interval (td) Settable Range (FAST C-t)

Data Transfer Mode	Output Data Format	Function	MEAS SPEED	Measurement Interval (td) Settable Range							
				10µs~	10ms~	20ms~	50ms~	100ms~	150ms~	200ms~	250ms ~ 52s
Standard Data Transfer Mode	ASCII	C·G-t	FAST	SAMPLING					BURST		
			MED	SAMPLING					BURST		
		C-t or G-t	FAST	SAMPLING				BURST			
			MED	SAMPLING				BURST			
	Binary	C·G-t	FAST	SAMPLING			BURST				
			MED	SAMPLING			BURST				
		C-t or G-t	FAST	SAMPLING		BURST					
			MED	SAMPLING		BURST					
Block Data Transfer Mode	ASCII or Binary	C·G-t	FAST	SAMPLING			BURST				
			MED	SAMPLING			BURST				
	C-t or G-t	FAST	SAMPLING	BURST							
		MED	SAMPLING		BURST						

* If td is shorter than 5s, SAMPLING mode can be selected via the HP-IB by sending remote program code "SA1."

For local operation, use the shaded area of the table.

Example of External Pulse Bias FAST C-t Measurement

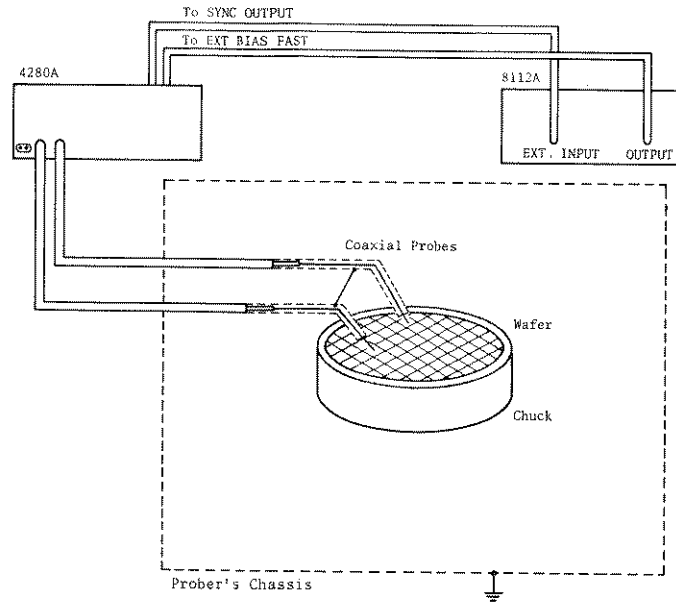

1. Interconnect the 4280A and pulse generator (HP8112A or equivalent) as shown above.

Note

The output impedance of the pulse generator should be 50Ω

2. Connect the test fixture or test leads to the UNKNOWN terminals.
3. Turn on the 4280A and pulse generator. The pulse generator's output should be disabled at this point.
4. Set the 4280A to C-t mode, and then set connection mode, INTERNAL BIAS mode, and SWEEP MODE as follows.

Connection Mode CN13
INTERNAL BIAS OFF
SWEEP MODE SINGLE
5. Set the pulse generator to EXT WIDTH mode (E. WID on the 8112A), and adjust the EXT INPUT threshold to the proper TTL level (SYNC OUTPUT signal of the 4280A).
6. Set the NO OF READINGS, th, and td parameters on the 4280A, and set pulse HIGHT and OFFSET voltage (HIL and LOL, respectively, on the 8112A) on the pulse generator.

7. Enable the pulse generator.

8. Perform internal or external error correction as described in paragraphs 3-41 and 3-56, respectively.

9. Connect the device to be tested.

10. Press the SWEEP/V OUTPUT key to start the measurement. The red V OUTPUT lamp will light and the time at the first measurement will appear on the V-t display. C and G displays will display --- --.

11. Capacitance and conductance measured at the time displayed on the V-t display are displayed on the C and G displays, respectively, and will remain until the next measurement at the next specified time is completed.

12. The red V OUTPUT lamp will go off after the specified NO OF READINGS have been taken.

13. Remove the test device.

Note

An X-Y recorder and a listen only printer can be used only when td is relatively long. Block data transfer mode is recommended for C-t mode measurements. Refer to paragraph 3-194.

Figure 3-33. External Pulse Bias FAST C-t Measurement Example

Example of HP-IB Controlled External Pulse Bias FAST C-t Measurement

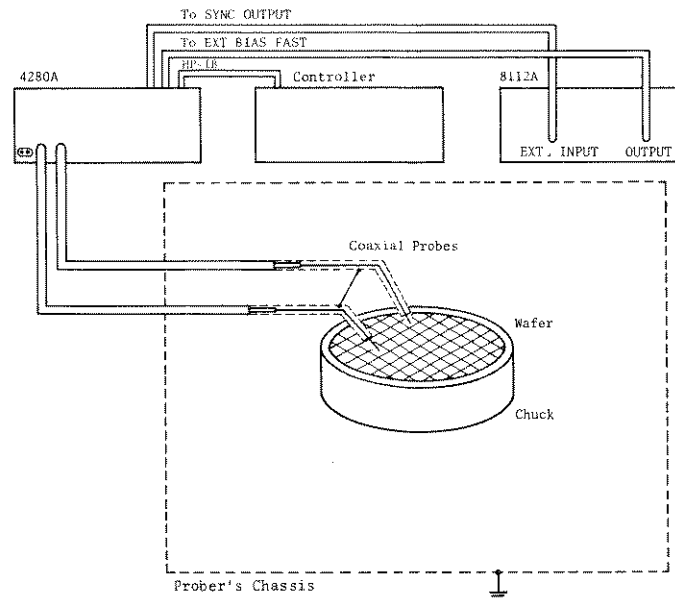

1. Interconnect the 4280A and controller using an HP-IB cable. If the pulse generator is capable of HP-IB control, interconnect the pulse generator too.
2. Interconnect the 4280A and the pulse generator as shown above.
3. Turn on the 4280A, the pulse generator, and the controller.
4. Load one of the sample programs listed in Figure 3-42. (Sample programs given in Figure 3-42 do not control the pulse generator via the HP-IB.)
5. Set the pulse generator to EXT WIDTH mode, and adjust the EXT INPUT threshold to the proper TTL level.
6. Connect the device to be tested.
7. Run the program. Measurement results will be printed out on the controller's CRT.

Figure 3-34. HP-IB Controller External Pulse Bias FAST C-t Measurement Example

3-156. X-Y RECORDER OUTPUTS

3-157. The 4280A is equipped with C·G, G and V·t analog RECORDER OUTPUTS and a SMOOTHING switch on the rear panel. These BNC connectors, which output dc voltages proportional to the displayed values, can be connected to an X-Y Recorder to plot measured values of the device under test as functions of bias voltage or time. A PEN LIFT connector is also provided for use with X-Y Recorders equipped with remote pen lift control. The procedure for setting up an X-Y recorder to plot the C-V characteristics of a sample is given in Figure 3-35.

3-158. The C·G, G, and V·t analog outputs are each described below.

(1) C·G Connector Analog Output

DC voltage output from the C·G connector is proportional to the number of counts displayed on the C display when the C-G or C function is selected. When the G function is selected, output voltage is proportional to the number of counts shown on the G display.

Displayed counts	Analog Output Voltage (V)
- 190000 ~ - 1000	- 10
- 999 ~ 999	$0.01 \times (\text{counts})$
1000 ~ 190000	+ 10
* OF - xx	+ 10

*Refer to Table 3-3 for the meanings of the various overflow annunciations.

(2) G Connector Analog Output

DC voltage output from the G connector is proportional to the number of counts displayed on the G display when the C·G or G function is selected. When C function is selected, output from the G connector is 0V.

Displayed Counts	Analog Output Voltage (V)
- 19000 ~ - 1000	- 10
- 999 ~ 999	$0.01 \times (\text{counts})$
1000 ~ 19000	+ 10
* OF - xx	+ 10

*Refer to Table 3-3 for the meanings of the various overflow annunciations.

(3) V·t Connector Analog Output

DC voltage output from the V·t connector depends on the selected measurement mode, as described below.

C Mode:

DC voltage output from the V·t connector increases 20mV per each measurement trigger. When +10V is reached, the output voltage returns to -10V and the cycle repeats. The plot starting point can be selected with the front panel X-Y RECORDER LL, ZERO, or UR key when TRIGGER is set to HOLD/MAN.

C-V Mode:

DC voltage output from the V·t connector is proportional to the value displayed on the V·t display. Maximum resolution is 20mV. Output voltage can be calculated using the formula:

$$\frac{C-B}{A-B} \times 20 - 10 \text{ (V)}$$

where A is the more positive of the START/STOP voltages, B is the more negative of the START/STOP voltages, and C is the output voltage from the internal dc bias source (value shown on the V·t display).

C·t Mode:

DC voltage output from the V·t connector is proportional to the value displayed on the V·t display. Maximum resolution is 20mV. Output voltage can be calculated using the formula:

$$\frac{K}{N} \times 20 - 10 \text{ (V)}$$

where K is a given measurement point (K = 1th, 2th, Nth measurement), and N is the total number of measurements (NO. OF READINGS).

If the displayed C or G value exceeds ± 1000 counts, the analog recorder outputs will be saturated at ± 10 volts. When this occurs, it is still possible to plot the measured data on an X-Y recorder by reducing the number of displayed counts using the front panel DIGIT SHIFT keys.

The front panel MATH keys can be used to increase the sensitivity of the X-Y recorder outputs, thereby making it possible to plot minute changes in measured capacitance or conductance values on an X-Y recorder.

3-159. The PEN LIFT connector outputs a TTL level signal which can be used to control the X-Y recorder's pen. When the output is HIGH, the pen is up; when LOW, the pen is down. When C mode is selected, the PEN LIFT output is HIGH (pen up).

3-160. The SMOOTHING switch sets the time constant of the RECORDER OUTPUTS' analog filters. This switch also controls the PLOT WAIT function. The existing PLOT WAIT setting, *P - o f f* or *P - o n*, can be observed on the G display for about one second by first pressing the blue key and then the LOCAL key.

(1) TIME CONSTANT (Response time)

The time constant for all three recorder outputs can be set to either 0.2 seconds or 0.02 seconds (accuracy not specified). The 0.2 second time constant provides smooth plots of capacitance or conductance characteristics that vary slowly with changes in voltage or time. The 0.02 second time constant, however, allows the recorder outputs and the X-Y recorder to respond to sudden changes in measured capacitance or conductance. The time constant chosen also depends on the slewing speed of the X-Y recorder used.

(2) PLOT WAIT

The PLOT WAIT switch controls the PEN LIFT signal between the first and last measurements made in the C·V or C·t mode. When PLOT WAIT is set to ON, the PEN LIFT output goes LOW (pen down) two seconds after the first measurement is made. The output remains LOW until 1.5 seconds after the last measurement has been made, at which time the PEN LIFT output goes HIGH (pen up). The initial two second wait time does not occur in the C·t (burst) mode, however, because the time between measurements is determined by the delaytime (td) setting. When PLOT WAIT is set to OFF, there is no initial wait time. Also, the PEN LIFT output goes HIGH as soon as the last measurement is made, causing the pen to lift before the last measurement value is plotted. PLOT WAIT OFF should be selected when an X-Y recorder is not used, or when the recorder outputs are used with high speed X-Y display equipment, such as the HP 1311B Large Screen Display (CRT).

X-Y RECORDER SETUP

- (1) Turn the 4280A and X-Y recorder off.
- (2) The 4280A's RECORDER OUTPUTS are located on the rear panel. Connect the X-Y recorder's X axis input to the V-t connector; the Y axis input to the C-G connector. If the recorder is equipped with remote pen lift control, connect the pen lift input to the PEN LIFT connector.
- (3) Turn the 4280A and X-Y recorder on.
- (4) Set the 4280A SWEEP MODE to SINGLE, and the rear panel SMOOTHING switch to 0.02 sec/ON (PLOT WAIT/ON). Set the instrument's controls as appropriate for the desired measurement. When setting the STEP DELAY TIME, the response time (slewing speed) of the X-Y recorder must be considered.
- (5) Place chart paper on the X-Y recorder platen and set the CHART switch to HOLD. PEN switch should be set to UP.
- (6) Using the 4280A's LL, ZERO, and UR keys and the X-Y recorder's controls, set the plot for the desired area. Refer to the following examples.

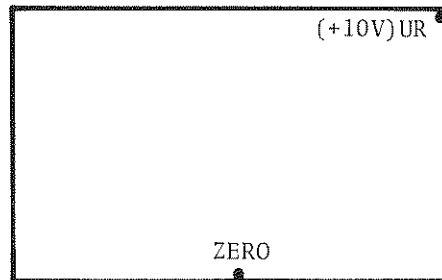

A. Plot area for positive measurement results

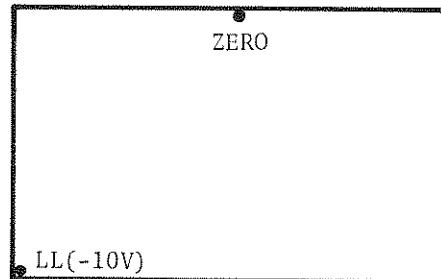

B. Plot area for negative measurement results

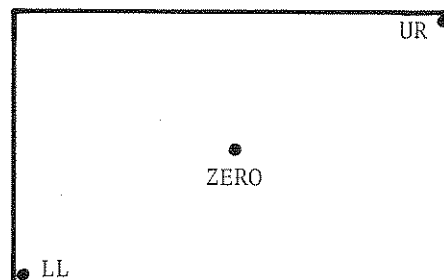

C. Plot area for negative and positive measurement results.

Figure 3-35. Procedure for setting up an X-Y recorder to plot C-V characteristics (Sheet 1 of 2)

- (7) Manually raise the pen and perform a single sweep measurement. Note the highest displayed capacitance value.
- (8) Set the 4280A to the C·G RANGE of the capacitance value noted in step (7). If the displayed measurement value is expected to exceed ± 1000 counts at any time during the measurement, compensate for this by using the DIGIT SHIFT keys or MATH function.

Note

When C·G RANGE is set to AUTO, the C·G range may change due to the C·V characteristics of the device under test. When the range changes, X-Y recorder outputs will be rescaled. To prevent this, set C·G RANGE to MANUAL. When MATH% or Δ % function is set, the recorders outputs will not be rescaled if the C·G range changes.

- (9) Manually lower the pen and press the SWEEP/V OUTPUT key to start the measurement. The PEN LIFT output will go LOW (pendown) and the plot will start. If the X-Y recorder is not equipped with remote penlift control, set the recorder's PEN switch to DOWN as soon as the pen reaches the first measurement point.
- (10) When the sweep ends (V OUTPUT lamp goes out), the PEN LIFT output will go HIGH (pen up). If the X-Y recorder is not equipped with remote pen lift control, set the recorder's PEN switch to UP when the sweep ends.

Figure 3-35. Procedure for setting up an X-Y recorder to plot C-V characteristics (Sheet 2 of 2)

3-161. C-HIGH RESOLUTION (OPTION 001 UNITS ONLY)

3-162. Option 001 equips the standard 4280A with a high resolution capacitance measurement function. This function allows the 4280A to measure capacitance with one additional digit of display resolution on the 100pF and 1nF ranges, thus increasing measurement resolution on these ranges to 1fF and 10fF, respectively.

With the C-HIGH RESOLN function set to on, the 4280A measures only the difference between the capacitance of the device under test and a user-specified offset capacitance. (More on offset capacitance later.) Since the difference-capacitance is usually much smaller than either the offset capacitance or the capacitance of the device being measured, the 4280A can measure on a lower, more sensitive range. The measured difference capacitance is then algebraically summed with the offset capacitance value to obtain the actual capacitance of the device under test.

For example, suppose the device under test has an actual capacitance of 25.125pF. If the C-HIGH RESOLN function is turned off, the 4280A will measure the device on the 100pF range. But because maximum resolution on this range is only 10fF (.01pF), the measured value displayed on the front panel will be 25.12pF. The 4280A will not be able to measure the .005pF portion of the actual capacitance, 25.125pF.

If the C-HIGH RESOLN function is turned on and an offset capacitance of, say, 20pF is set, however, the 4280A will measure on the 10pF range because only the small difference between the actual capacitance and the offset capacitance, 5.125pF (25.125pF minus 20pF) in this example, will be measured. The 5.125pF difference capacitance is easily measured on the 10pF range, without loss of resolution. Finally, the microprocessor adds the measured difference capacitance to the offset capacitance value and then displays the result on the front panel.

The offset capacitance is actually an internally generated ac offset current that is exactly 180° out of phase with the current through the device under test. The amplitude of the offset current is proportional to the user-specified offset capacitance. When the C-HIGH RESOLN function is turned on, the offset current is

injected into the measurement circuit along with the current through the device being measured. Since these two ac currents are of opposite phase, they have a canceling effect on each other. Only the difference between the two currents enters the measurement circuit.

Offset capacitance values from 0pF to 1023pF can be set. Setting resolution is 1pF. Offset capacitance can be set in two ways: C-OFFSET MEASURED or C-OFFSET MANUAL. C-OFFSET MEASURED automatically sets an offset capacitance value that is nearly equal to the measured capacitance of the device under test. C-OFFSET MANUAL allows manual entry of the desired offset capacitance with the numeric keys. The two procedures for setting the offset capacitance value are given in paragraph 3-163. Setting accuracy information is given in Table 1-2, Supplemental Performance Characteristics. Table 3-29 shows the usable measurement ranges, full scale capacitance and conductance values, maximum display digits, and measurement resolution for various combinations of measurement speed, signal level, and measurement range when the C-HIGH RESOLN function is used. Figure 3-36 provides more information on the C-HIGH RESOLN function.

Table 3-29. Usable Ranges for C-HIGH RESOLN

MEAS SPEED	SIG LEVEL	RANGE	
		100pF / 1mS (10pF / 100μS)	1nF / 10 mS (100pF / 1mS)
FAST	10 / 30	0~190.00 pF	0~1200.0 pF*
MED	10	0~120.0 μS	0~1.200 mS
	30	0~190.000 pF	0~1200.00 pF*
SLOW	10 / 30	0~120.00 μS	0~1.2000 mS

* indicates approximate values.

Ranges enclosed in parentheses are the actual measurement ranges.

3-163. Offset capacitance can be set automatically with the C-OFFSET MEASURED key or manually with the C-OFFSET MANUAL key and numeric keys. The procedures are given below.

[C-OFFSET MEASURED]

1. Turn the 4280A on, connect a test fixture or test leads to the UNKNOWN terminals, and perform internal error correction as described in paragraph 3-41.
2. Connect the device to be measured to the 4280A.
3. Press the C-HIGH RESOLN key. The lamp at the center of the key will light.
4. Press the blue key. The lamp at the center of the key will light.
5. Press the C-OFFSET MEASURED key. The 4280A will stop measurement, the existing offset capacitance and conductance will appear on the C and G displays, respectively, and $\square - \square F$ will appear on the V-t display.
6. Press the ENTER key. Dashes will appear on the C and G displays until the capacitance offset measurement is completed--about one second in C mode; longer in C-V and C-t modes (actual time depends on t_h and t_d). After the capacitance offset measurement, the offset values will appear briefly on the C and G displays, and then high resolution measurements will begin.

[C-OFFSET MANUAL]

1. Turn the 4280A on, connect a test fixture or test leads to the UNKNOWN terminals, and perform internal error correction as described in paragraph 3-41.
2. Turn off the internal error correction function by pressing the CORRECTION ENABLE key. The lamp at the center of the key will go out.
3. Connect the device to be measured to the UNKNOWN terminals.
4. Perform a measurement and note the measured capacitance.
5. Turn on the internal error correction function by pressing the CORRECTION ENABLE key again. The lamp at the center of the key will light.

6. Press the C-HIGH RESOLN key. The lamp at the center of the key will light.
7. Press the blue key. The lamp at the center of the key will light.
8. Press the C-OFFSET MANUAL key. The 4280A will stop measurement, the existing offset capacitance and conductance will appear on the C and G displays, respectively, and $\square - \square F$ will appear on the V-t display.
9. Key in the desired offset capacitance value (must be between 0 and 1023 counts) with the numeric keys. The value will be in picofarads.

Note

The difference between the offset capacitance and the capacitance noted in step 4 must not exceed the full scale value of the range below the range used in step 4. For example, if the 1nF range was used in step 4, the difference must not exceed the fullscale value of the 100pF range ($\pm 190\text{pF}$). If the 100pF or 1nF range was used in step 4, offset capacitance lower than 19pF or 190pF, respectively, cannot be entered.

10. Press the ENTER key. Dashes will appear on the C and G displays until the capacitance offset measurement is completed--about one second in C mode; longer in C-V and C-t modes (actual time depends on t_h and t_d). After the capacitance offset measurement, the offset values will appear briefly on the C and G displays, and then high resolution measurements will begin.

Note

Because of internal error correction, rounding, etc., the offset capacitance value actually used will be slightly different from the value entered with the C-OFFSET MEASURED or C-OFFSET MANUAL keys. The actual offset capacitance value can be displayed by pressing the blue key and then either the C-OFFSET MEASURED key or C-OFFSET MANUAL key. To return to measurement mode without changing the offset capacitance, simply press the blue key again.

The following is a simplified discussion of the C-HIGH RESOLN function. The various values used by the C-HIGH RESOLN function are described in the table below. The actual values can be displayed by setting the C-HIGH RESOLN and CORRECTION ENABLE keys as shown in the table.

C-HIGH RESOLN	CORRECTION ENABLE	Displayed Capacitance
OFF	ON	C1. Error-corrected capacitance of the device under test.
OFF	OFF	C2. Uncorrected capacitance of the device under test.
ON	OFF	C3. Difference between the offset capacitance and C2.
V.t 		C4. Offset capacitance entered with the C-OFFSET MEASURED or C-OFFSET MANUAL key.
		C5. Actual offset capacitance.
ON	ON	C6. High resolution capacitance of the device under test.

When the ENTER key is pressed after the C-OFFSET MEASURED key has been pressed or after the offset capacitance value has been keyed in, the 4280A performs the following series of operations automatically.

1. C4 is digitally set in the C-offset circuit.
2. C2 and C3 are each measured in order to determine the most appropriate value for C5. Because C3 is very small, it is measured on a lower range than the range used to measure C2.
3. C5 is calculated as follows.

$$C5 = C2 - C3$$

C5 is then displayed on the C display and memorized as the offset capacitance. Note that, because C3 has higher resolution than C2, C5 will have an additional digit.

Figure 3-36. C-HIGH RESOLN Function (Sheet 1 of 2)

When internal error CORRECTION is disabled:

The 4280A measures only C3, the difference between the offset capacitance C5 and the uncorrected capacitance of the device under test. Only C3 is displayed when the internal error correction function is disabled. Also, C3 is measured on a lower range than the range used to measured C2.

When internal error CORRECTION is enabled:

The 4280A measures only C3 and sums the measured value with C5. Error compensation is performed on the summation result and the compensated value is displayed, C6.

The following illustration shows the relationships among capacitance values C1 through C6.

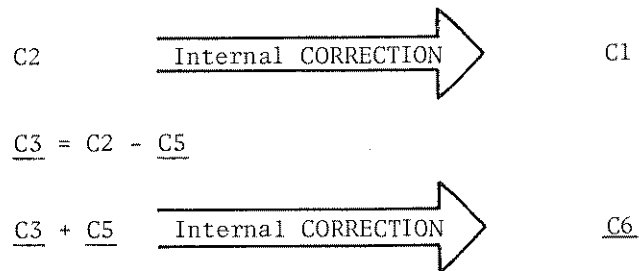

* Underlined values have high resolution.

Figure 3-36. C-HIGH RESOLN Function (Sheet 2 of 2)

3-164. HP-IB INTERFACE

3-165. The 4280A can be remotely controlled via the HP-IB, a carefully defined instrument interface that simplifies integration of programmable instruments and a computer into a system. The remainder of Section III, paragraphs 3-166 through 3-224, describes the 4280A's HP-IB capabilities and how they are used.

Note

HP-IB is Hewlett-Packard's implementation of IEEE Std. 488, Standard Digital Interface for Programmable Instrumentation.

3-166. HP-IB INTERFACE CAPABILITIES

3-167. The 4280A has eight HP-IB interface functions, as listed in Table 3-30.

Table 3-30. HP-IB Interface Capabilities

Code	Interface Function* (HP-IB Capabilities)
SH1**	Source Handshake
AH1	Acceptor Handshake
T5	Talker (basic talker, serial poll, talk only mode, unaddress to talk if addressed to listen)
L4	Listener (basic listener, unaddress to listen if addressed to talk)
SR1	Service Request
RL1	Remote/local (with local lockout)
DC1	Device Clear
DT1	Device Trigger
<p>* Interface functions provide the means for a device to receive, process, and transmit messages over the bus.</p> <p>** The numeric suffix of the interface code indicates the limitation of the function, as defined in Appendix C of IEEE Std. 488. 1978.</p>	

3-168. CONNECTION TO HP-IB

3-169. The 4280A can be connected into an HP-IB bus configuration with or without a controller (i.e., with or without an HP computer). In an HP-IB system without a controller, the instrument functions as a "talk only" device (refer to paragraph 3-176).

3-170. HP-IB STATUS INDICATORS

3-171. The HP-IB Status Indicators are four LED lamps located on the front panel. When lit, these lamps show the existing status of the 4280A in the HP-IB system as follows:

SRQ: SRQ signal from the 4280A to the controller is on the HP-IB line. Refer to paragraph 3-221.

LTN: The 4280A is set to listener.

TLK: The 4280A is set to talker.

RMT: The 4280A is under remote control.

3-172. LOCAL KEY

3-173. The LOCAL key releases the 4280A from HP-IB remote control and allows measurement conditions to be set from the front-panel. The RMT lamp will go off when this key is pressed. LOCAL control is not available when the 4280A is set to "local lockout" status by the controller.

3-174. HP-IB ADDRESS SWITCHES

3-175. The HP-IB switches are two miniature rotary switches located on the rear panel. Figure 3-37 shows the switches. The setting of these switches determines whether the 4280A will be addressed by the controller in a multi-device system, or will function as a "talk only" device, outputting measurement data to an external "listen only" device, a printer for example. Addresses 0 through 30 set the 4280A to ADDRESSABLE mode; address 50 and 51 set the 4280A to TALK ONLY mode. Refer to Table 3-31. More information on the TALK ONLY mode and ADDRESSABLE mode is given in paragraphs 3-176, and 3-178, respectively. Figure 3-37 shows the HP-IB switches set to address 17, the factory set address.

Table 3-31. HP-IB Mode Selection

HP-IB Switch Setting	HP-IB Mode
0 through 30	ADDRESSABLE
50 or 51	TALK ONLY

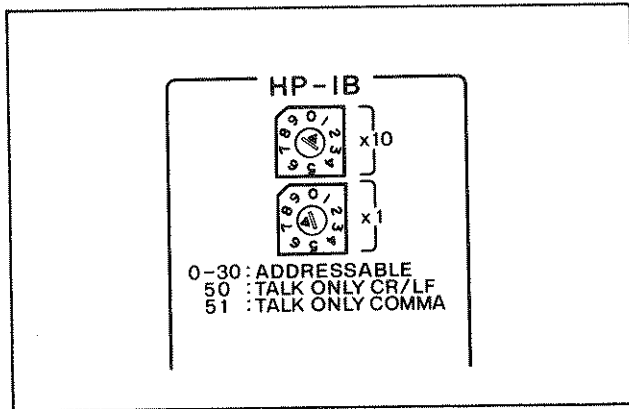

Figure 3-37. HP-IB Address Switches

Note

The setting of the HP-IB address switches is read only at instrument power on. Thus, you must cycle the instrument's ON/OFF switch whenever the switch settings are changed.

3-176. TALK ONLY MODE

3-177. The 4280A is in TALK ONLY mode when the HP-IB address switches are set to 50 or 51. In this mode, the 4280A functions as a "talker," outputting data to a "listener," a printer for example. The delimiter for the output data (C display data, G display data, and V·t display data) depends on the setting of the HP-IB address switches. When 50 is set, the delimiter is CR/LF (carriage return/line feed); when 51 is set, the delimiter is a comma (,). Refer to Tables 3-32 and 3-33. Paragraph 3-188 gives a detailed description of the TALK ONLY mode output data.

Table 3-32. Output Data Delimiters--TALK ONLY Mode

HP-IB Address Switch Setting	Data Delimiter
50	ⓄⓂ ⓄⓁⓕ
51	Comma (,)

ⓄⓂⓄⓁⓕ: Output after each display's output data. Instructs the printer to perform a carriage return/line feed after printing each display's output data.

Comma (,): Output after each display's output data. Instructs the printer to print a comma (,) after each display's output data. A carriage return/line feed will be performed after the last output data is printed. Refer to Table 3-33.

Note

When the 4280A is set to TALK ONLY mode, devices connected to it must be set to LISTEN ONLY mode.

Note

When the 4280A is set to TALK ONLY mode, the following will appear briefly on the C display each time the 4280A is turned on, and each time the blue key and LOCAL key are sequentially pressed.

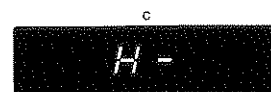

Note

When the 4280A is set to TALK ONLY mode, ASCII data output format is automatically selected.

3-178. ADDRESSABLE MODE

3-179. The 4280A is in ADDRESSABLE mode when the HP-IB address switches are set to a value between 0 and 30, inclusive. the factory-set address is 17, but any address from 0 to 30 can be set. In ADDRESSABLE mode, the 4280A can be completely controlled by a controller (computer) through the HP-IB. All front panel keys, except the INT BIAS switch and the LINE ON/OFF switch, and all measurement parameters (voltage and time) can be set by remote program codes. Refer to paragraph 3-180.

Note

When the 4280A is set to ADDRESSABLE mode, the HP-IB address will appear briefly on the C display each time the 4280A is turned on, and each time the blue key and LOCAL key are sequentially pressed. The figure below shows the display for the factory set address, 17.



3-180. REMOTE PROGRAM CODES

3-181. Table 3-34 lists all the program codes for controlling the front panel keys. Table 3-35 lists the program codes for setting measurement parameters.

Note

Alphabetic characters used in the remote program codes can be upper case, lower case, or both. All the following examples are acceptable.:

FN1, fn1, Fnl, fN1

Note

Remote program codes for each front panel key correspond to the underlined letters of the key labels printed on the front panel. For example,

FUNCTION is FN
MEAS SPEED is MS

Table 3-33. Output Data Format--TALK ONLY Mode (51)

Measurement Mode	Measurement Function	Output Data						
C Mode	C-G	C Data	Comma	G Data	Ⓞ	Ⓞ		
	C	C Data	Ⓞ	Ⓞ				
	G	G Data	Ⓞ	Ⓞ				
C-V Mode	C-G	C Data	Comma	G Data	Comma	V Data	Ⓞ	Ⓞ
	C	C Data	Comma	V Data	Ⓞ	Ⓞ		
	G	G Data	Comma	V Data	Ⓞ	Ⓞ		
C-t Mode	C-G	C Data	Comma	G Data	Comma	T Data	Ⓞ	Ⓞ
	C	C Data	Comma	T Data	Ⓞ	Ⓞ		
	G	G Data	Comma	T Data	Ⓞ	Ⓞ		

Table 3-34. Remote Program Codes (Sheet 1 of 4)



Control		Program Code	Remarks	
FUNCTION	C-G	FN1*	C-G measurement or C-G-V measurement Key indicator is lit.	
	C	FN2		C measurement or C-V measurement
	G	FN3		G measurement or G-V measurement
	C-G-t	FN4	C-G-t measurement Key indicator blinks.	
	C-t	FN5		C-t measurement
	G-t	FN6		G-t measurement
CONNECTION MODE	FLOATING	FL*	Connection Mode CN10	
	GROUNDING	GN	Connection Mode CN15	
	CONN MODE (10 - 23)	CN10* through CN23	Connection Modes CN10 through CN23	
INTERNAL BIAS	OFF (OFF)	IB0	Internal bias modes enclosed in parentheses apply when the 4280A is in C-t mode.	
	== (==)	IB1*		
	 (Lr)	IB2		
		IB3		
C-G RANGE	MANUAL	RA0	If RM1, RM2, or RM3 is sent, RA0 is automatically set.	
	AUTO	RA1*		
	10pF/100µS	RM1		
	100pF/1mS	RM2		
	1nF/10mS	RM3		
MEAS SPEED	FAST	MS1	MEAS SPEED MS3 (SLOW) cannot be used when the 4280A is set to C-t mode.	
	MED	MS2*		
	SLOW	MS3		
SIG LEVEL	10mVrms	SL1		
	30mVrms	SL2*		

Table 3-34. Remote Program Codes (Sheet 2 of 4)

Control		Program Codes	Remarks
TRIGGER/ SWEEP MODE	INT (REPEAT)	TR1*	Sweep modes (enclosed in parentheses) apply when the 4280A is in C-t or C-V mode.
	EXT (EXT)	TR2	
	HOLD/MAN (SINGLE)	TR3	TR3 selects TRIGGER HOLD but does not trigger the 4280A.
		EX	Triggers the 4280A. Cannot be used when the 4280A is set to C-V or C-t mode.
SWEEP/ V OUTPUT	RESET (==)	VO0*	
	SET (==)	VO1	
	STOP	SW0	SW1 is ignored during a C-V mode or C-t mode measurement.
	START	SW1	
CORRECTION ENABLE	OFF	CE0	
	ON	CE1*	
CABLE LENGTH	0m	LE1*	
	1m	LE2	
	0 - 5m	LE3	
ZERO OPEN		Z0	
CAL START		CA	
DIGIT SHIFT C		DC0*	Full digit display on the C display
		DC1	Shifts one digit.
		DC2	Shifts two digits.
		DC3	Shifts three digits (Cannot be used on the 100pF range or, when MEAS SPEED is FAST, on the 10pF range.).
		DC4	Shifts four digits (Can be used on the 1nF range only.).
DIGIT SHIFT G		DG0*	Full digit display on the G display
		DG1	Shifts one digit.
		DG2	Shifts two digits.
		DG3	Shifts three digits (Cannot be used on the 100µS range.).
		DG4	Shifts four digits (Cannot be used on the 1mS range.).

Table 3-34. Remote Program Codes (Sheet 3 of 4)

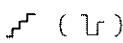
Control		Program Codes	Remarks
MATH	OFF	MA0*	
	Δ	MA1	
	%	MA2	
	$\Delta\%$	MA3	
STORE DISPL C·G		ST	
SELF TEST	OFF	TE0*	
	ON	TE1	
C-HIGH RESOLN	OFF	CH0*	CH1 cannot be set if the 4280A is not equipped with Option 001.
	ON	CH1	
C-OFFSET	MEASURED	CS	Valid only when CH1 has been sent.
X-Y RECORDER	\downarrow LL	LL	Valid only when TR3 (in C mode) or SW0 (in C-V mode or C-t mode) has been sent.
	ZERO	ZE	
	UR \rightarrow	UR	
Data Output Format	Standard Data Transfer Mode	BLO*	Refer to paragraph 3-204 for details on data output format.
	Block Data Transfer Mode	BL1	
SRQ Mask		MD0*	MD0 turns on the Data Ready SRQ mask, MD1 turns it off. Refer to paragraph 3-221.
		MD1	
Integration Mode	Burst Mode	SA0*	Applicable in C-t mode only. Refer to paragraph 3-122.
	Sampling Mode	SA1	
Data Output Format	ASCII	AS*	Applicable in Standard Data Transfer Mode. Refer to paragraph 3-208.
	BINARY	BN	
	ASCII	BA	Applicable in Block Data Transfer Mode. Refer to paragraph 3-194.
	BINARY	BB	
Buffer Clear		BC	Clears the output data buffer.

Table 3-34. Remote Program Codes (Sheet 4 of 4)

Control	Program Codes	Remarks
LEARN MODE	MF?	Refer to paragraph 3-219 for details on LEARN MODE.
	CF?	
	SET?	
	ERR?	
	BS?	
	ID?	
Isolate	IS0*	Normal operation
	IS1	Isolate state (refer to paragraph 3-214.)
<ul style="list-style-type: none"> • indicates an initial control setting. 		

Table 3-35. Remote Program Codes for Measurement Parameters

Parameter	Program Code	Initial Value	Remarks
PARAMETER			
DC V (V)	PV	0V	Refer to paragraph 3-64.
START V (V)	PS	0V	
STOP V (V)	PP	0V	Refer to paragraph 3-72.
STEP V (V)	PE	0V	
HOLD TIME (s)	PL	3ms	
STEP DELAY TIME (s)	PD	3ms	
DC V (V)	PV	0V	Refer to paragraph 3-88.
PULSE V (V)	PU	0V	
MEAS V (V)	PM	0V	
NO OF READINGS	PN	100	
th (s)	PH	10ms	
td (s)	PT	250ms	
V LIMIT/RNG HOLD	VL	0V	Refer to paragraph 3-62.
C-REF	CR	0pF	Refer to paragraph 3-43.
G-REF	GR	0 μ S	
C-OFFSET MANUAL	CL	0pF	Refer to paragraph 3-161.

3-182. SETTING PARAMETERS VIA THE HP-IB

3-183. Voltage parameters, time parameters, number of readings for C-t mode measurements, limit voltage, reference values for the MATH functions, and offset capacitance for C-HIGH RESOLN measurements (option 001) can all be set via the HP-IB with an HP-IB compatible computer. Examples of setting each parameter are given below. The units used in the following examples are volts (V) for voltage, seconds (s) for times, farads (F) for capacitance values, and siemens (S) for conductance values.

Note

Parameters of a parameter string must be separated by an appropriate delimiter. Valid delimiters for the 4280A are commas (,), colons (:), and semicolons (;). Any combination of delimiters can be used in a parameter string, as shown in the following example.

PS10, PP20; PE5; PL0.1

Note

If the polarity of a parameter is not specified, positive polarity (+) is assumed.

- (1) DC V (V) for C mode; remote program code PV:

Voltage output from the 4280A's internal dc bias source during C mode operation. Upper limit is either $\pm 42V$ or $\pm 100V$ depending on the setting of the INT BIAS switch. Can be set with a maximum 3-1/2 digits. Maximum resolution is 1mV.

Example:

PV12.34

- (2) START V (V) and STOP V (V); remote program codes PS and PP;

Upper limit for both parameters is either $\pm 42V$ or $\pm 100V$ depending on the setting of the INT BIAS switch. Both parameters can be set with a maximum 3-1/2 digits. Maximum resolution is 1mV.

Example:

PS-1.234, PP34.5

Note

START V and STOP V are independently set to the range that provides the best resolution. When displayed on the V-t display or recalled by the LEARN mode function, resolution will be determined by the larger of the two values. For the example given,

START V -1.2V (-1.234V)
STOP V 34.5V

- (3) STEP V (V); remote program code PE:

Bias sweep step voltage. Settable range is 0V to 200V. Can be set with 3-1/2 digits. Maximum resolution is 1mV. Negative values cannot be set.

Example:

PE2.50

- (4) HOLD TIME (s) and STEP DELAY TIME (s); remote program codes PL and PD:

Settable range for both parameters is 3ms to 650s. Can be set with 3-1/2 digits. Maximum resolution is 1ms.

Example:

PL36E-3, PD 98.76

- (5) DC V (V) for C-t mode; remote program code is PC:

Voltage output from the internal dc bias source during C-t mode operation. Upper limit is either $\pm 42V$ or $\pm 100V$ depending on the setting of the INT BIAS switch. Can be set with 3-1/2 digits. Maximum resolution is 1mV.

Example:

PC3.50

- (6) PULSE V (V) and MEAS V (V); remote program codes are PU and PM:

These are, respectively, the amplitude of the bias pulse and the measurement voltage output from the internal dc bias source. Upper limit for both parameter is either $\pm 42V$ or $\pm 100V$ depending on the setting of the INT BIAS switch. Both parameters can be set with a maximum 3-1/2 digits. Maximum resolution is 1mV.

Example:

PU1.500, PM-5.00

Note

PULSE V and MEAS V are independently set to the range that provides the best resolution. When displayed on the V-t display or recalled by the LEARN mode function, resolution will be determined by the larger of the two values. For the example given,

PULSE V 1.50V (1.500V)
MEAS V -5.00V

- (7) NO OF READINGS; remote program code PN:

Settable range is 1 to 9999.

Example:

PN 1000

- (8) th (s) and td (s)--pulse width and measurement interval; remote program codes PH and PT:

Settable range for both these parameters is 10 μ s to 32s. Both can be set with 4 digits. Maximum resolution is 10 μ s.

Example:

PH 10.00E-3, PT 250.0E-3

Note

Settable range for th and td depends on other parameters and control settings. Refer to Tables 3-16, 3-23, 3-26 for th, and to Tables 3-19, 3-25, and 3-28 for td.

- (9) V LIMIT/RNG HOLD; remote program code is VL:

This parameter sets the output voltage limit for the internal dc bias source and determines the range, and therefore the resolution, of other voltage parameter settings. Maximum allowable setting is 100V. Can be set with 3-1/2 digits. Maximum resolution is 1mV. The V LIMIT setting applies to both positive and negative output voltages. If 0V is specified, the voltage output is limited only by the INT BIAS switch and range selection is automatic.

Example:

VL 16.00

Note

The V LIMIT/RNG HOLD setting determines the upper limit of the DC V parameter in a C mode measurement, whether it was set before or after V LIMIT/RNG HOLD was set. This means that, if DC V was set to 100V and then V LIMIT/RNG HOLD is set to 50V, DC V will be automatically set to 50V. If the V LIMIT/RNG HOLD setting is later increased or set to 0 (no limit; auto-ranging), DC V will remain at 50V.

- (10) C-REF; remote program code is CR:

Reference value for the MATH functions. Settable range is 0 to $\pm 199.999nF$. Can be set with 5-1/2 digits. Maximum resolution is 0.01fF.

Example:

CR 10.0000E-12

- (11) G-REF; remote program code is GR:

Reference value for the MATH functions. Settable range is 0 to $\pm 19.999mS$. Can be set with 4-1/2 digits. Maximum resolution is 0.1nS.

Example:

GR 1.0000E-3

- (12) C-OFFSET MANUAL (option 001 only); remote program code is CL:

Offset capacitance for C-HIGH RESOLN measurements. Settable range is 0pF to 1023 pF in 1pF steps.

Example:

CL 123E-12

Note

Refer to paragraphs 3-58 through 3-163 for complete information on these parameters.

3-184. DATA OUTPUT

3-185. The 4280A can output measurement results and measurement status information to and external device via the HP-IB. As listed in Table 3-36, there are two data transfer modes--block and standard--and two data formats--ASCII and BINARY. Data formats are described in paragraphs 3-186 through 3-191; data transfer modes, starting in paragraph 3-192.

Table 3-36. Output Data Transfer Modes and Formats

Data Transfer Mode	Data Format
Block Data Transfer Mode	ASCII
	BINARY
Standard Data Transfer Mode	ASCII
	BINARY

3-186. OUTPUT DATA FORMAT

3-187. Measurement data can be output in either ASCII format or BINARY format. In ASCII format, each character requires one byte (8 bit). In BINARY format, output data is transferred in a packed binary code. ASCII and BINARY formats are selectable via the HP-IB. ASCII format is used for most measurements, but when high speed data transfer is required, BINARY format should be used. Table 3-42 lists the data transfer times for various combinations of controller, output data format, and measurement function. ASCII format is described in paragraph 3-188; BINARY format, in paragraph 3-190.

3-188. ASCII Format

3-189. Six types of data can be sent in ASCII format: C data, G data, V data, T data, L data, and R data. Each is described below.

[C Data]

C data consists of the measured capacitance value and measurement status.

$$\frac{nCn \pm \text{*****} E \pm **}{(1) (2) \quad (3) \quad (4)}$$

- (1) N or O:

N: Normal measurement
O: Overflow

- (2) M, D, P or Q:

M: MATH function not used.
D: Δ measurement
P: % measurement
Q: Δ% measurement

- (3) Measured capacitance value, including decimal point

- (4) Scientific notation exponent. Indicates the unit for the measured capacitance, (3). Set to zero (00) for % and Δ% measurements.

Note

If a measurement overflow occurs, the output data [(3) and (4)] will be +9.99999E+09.

[G Data]

G data consists of the measured conductance value and measurement status.

$$\frac{nGn \pm \text{*****} E \pm **}{(1) (2) \quad (3) \quad (4)}$$

- (1) N or O:

N: Normal measurement
O: Overflow

- (2) M, D, P or Q

M: MATH function not used
D: Δ measurement
P: % measurement
Q: Δ% measurement

- (3) Measured conductance value, including decimal point
- (4) Scientific notation exponent. Indicates the unit for the measured conductance, (3). Set to zero (0) for % and Δ % measurements.

Note

If a measurement overflow occurs, the output data [(3) and (4)] will be +9.9999E+9.

[V data]

V data is the voltage output from the internal dc bias source at each step of a C-V mode swept measurement.

$$\frac{V \pm \text{*****}}{(1)}$$

- (1) Voltage value, including decimal point. Unit is volts.

[T data]

Elapsed time (k·td) of a C-t mode measurement

$$\frac{T \text{*****} E \pm *}{(1) \quad (2)}$$

- (1) Value appearing on the V·t display, including decimal point.
- (2) Scientific notation exponent. Indicates the unit for the elapsed time (1); E-3 = ms, E + 0 = s.

[L data]

L data consists of the measured inductance value and measurement status. Used for external error correction. Inductance can be measured in connection modes CN21, CN22, and CN23 only.

$$\frac{nL \pm \text{*****} E - 6}{(1) \quad (2) \quad (3)}$$

- (1) N or O:
N: Normal measurement
O: Overflow
- (2) Measured inductance value. The position of the decimal point is fixed.
- (3) Scientific notation exponent ; always -6, μH

Note

If a measurement overflow occurs, the output data [(2) and (3)] will be +9.9999E+9.

[R data]

R data consists of the measured resistance value and measurement status. Used for external error correction. Resistance can be measured in connection modes CN21, CN22, and CN23 only.

$$\frac{nR \pm \text{*****}}{(1) \quad (2)}$$

- (1) N or O:
N: Normal measurement
O: Overflow
- (2) Measured resistance value. The position of the decimal point is fixed. Unit is Ω.

Note

If a measurement overflow occurs, the output data, (2), will be +999.99.

3-190. BINARY Format

3-191. Four types of data can be sent in BINARY format: status data, C data, G data, and K data. The 4280A can be set to BINARY format only under remote control. The remote program codes are listed in Table 3-34. When the 4280A is set to BINARY format, *bn* is displayed on the C, G, and V·t displays, as shown below.



Note

The RECORDER OUTPUTS and the error correction function cannot be used when the 4280A is set to BINARY format.

Status data, C data, G data, and K data are each described below.

[Status data]

Measurement status data is sent in one byte.

MSB		Bit Number						LSB	
7	6	5	4	3	2	1	0		
(1)	(2)	(3)		(4)	(5)				

(1) Data Validity

- 0: Data that follows is valid.
- 1: Data that follows is invalid.

(2) Final data of a swept measurement (C-V or C-t)

- 0: Data that follows is not the final data.
- 1: Data that follows is the final data.

Note

Bit 6 is always 1 in C mode.

(3) Not used. Always 0.

(4) Indicates number of full scale counts for C and G data.

- 0: 1000 counts
- 1: 10000 counts

(5) Measurement Range:

Bit Number			C·G Range
2	1	0	
0	0	1	10pF/100μS
0	1	0	100pF/ 1mS
1	0	0	1nF/ 10mS

[C data]

C measurement data, which consists of polarity and number of counts, is sent in two bytes.

MSB		Upper Byte						LSB	
7	6	5	4	3	2	1	0		
(1)	(2)								

Lower Byte							LSB
7	6	5	4	3	2	1	0
(3)							

(1) Polarity:

- 0: Positive (+)
- 1: Negative (-)

(2) Upper seven bits of the measured capacitance value (binary).

(3) Lower eight bits of the measured capacitance value (binary).

Note

The upper byte is sent before the lower byte. The data is represented using a 16-bit, two's-complement notation.

[G data]

G measurement data, which consists of polarity and number of counts, is sent in two bytes.

MSB		Upper Byte					
7	6	5	4	3	2	1	0
(1)	(2)						

Lower Byte							LSB
7	6	5	4	3	2	1	0
(3)							

(1) Polarity:

- 0: Positive (+)
- 1: Negative (-)

(2) Upper seven bits of the measured conductance value (binary)

(3) Lower eight bits of the measured conductance value (binary)

Note

The upper byte is sent before the lower byte. The data is represented using a 16-bit, two's-complement notation.

Note

If the measurement overflows, bit 7 of the status data (data invalid) is set, and C data and G data are 20000 (4-1/2 digits full scale) or 2000 (3-1/2 digits full scale).

20000(decimal)=0100 1110 0010 0000(binary)
 2000(decimal)=0000 0111 1101 0000(binary)

[K data]

K data, which is the number of a given measurement point of a C-V mode or C-t mode swept measurement, is sent in two bytes.

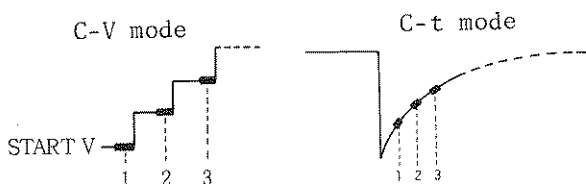

MSB								Upper Byte	
7	6	5	4	3	2	1	0		
0								(1)	

Lower Byte							LSB
7	6	5	4	3	2	1	0
(2)							

- (1) Upper seven bits of measurement point number (binary)
- (2) Lower eight bits of measurement point number (binary)

Note

The upper byte is sent before the lower byte. The data is represented using a 16-bit, two's-complement notation.

3-192. DATA TRANSFER MODE

3-193. The 4280A can send measurement data over the HP-IB in either of two modes: standard data transfer mode or block data transfer mode. In standard data transfer mode, the 4280A outputs data at the completion of each measurement, regardless of the measurement mode (C mode, C-V mode, or C-t mode). So, if the 4280A is making a swept measurement in which there are, say, 100 measurement points, measurement data will be sent 100 times, once for each measurement point. In block data transfer mode, however, the measurement data obtained at each measurement point is stored in the 4280A's internal buffer memory until the sweep is completed. After the final measurement, all the data in the buffer is dumped onto the HP-IB. Measurement data is sent only once, so the total time required to perform a swept measurement is reduced by an amount proportional to the number of measurement points.

Block data transfer mode is described in paragraphs 3-194 through 3-207. Standard data transfer mode is described starting in paragraph 3-208. Figure 3-38 shows the flow diagram for a C-V or C-t mode measurement made in block data transfer mode.

Note

Block data transfer mode can be used for C-V mode and C-t mode measurements only.

Note

The 4280A is set to standard data transfer mode at power on and after self test, and when it receives a "device clear."

3-194. BLOCK DATA TRANSFER MODE

3-195. Block data transfer mode makes it possible to perform very high speed C-V mode and C-t mode measurements because data is not transferred at each measurement point. Instead, data obtained at each measurement point is stored in internal buffer memory until the last measurement has been made, at which time the contents of the buffer are dumped onto the HP-IB. Buffer memory size is only 2K bytes, so the amount of measurement data that can be stored is limited. Refer to Table 3-37.

3-196. How To Get Into Block Data Transfer Mode

3-197. Block data transfer mode can be set only by remote program code, entered from a controller and sent via the HP-IB. The necessary remote program code is BLI.

Note

The 4280A cannot be set to block data transfer mode when the 4280A is set to connection mode CN21, CN22, or CN23.

Note

All front panel keys except the SWEEP/V OUTPUT key, LOCAL key, blue key, and FLOATING key are inoperative when the 4280A is set to block data transfer mode.

Note

The following operations cannot be performed under remote control while the 4280A is in block data transfer mode.

- (1) Set connection mode CN21, CN22, or CN23.
- (2) ZERO OPEN (ZO)
- (3) CABLE LENGTH CAL (CA)
- (4) Change the C-OFFSET value (CS or CLv) (Option 001).
- (5) SELF TEST (TE1)
- (6) Send remote program codes AS, BN, or TR1. These codes will be ignored.

- (7) Any operation that cannot normally be performed in C-V or C-t mode.

Note

The RECORDER OUTPUTS are disabled when the 4280A is set to block data transfer mode.

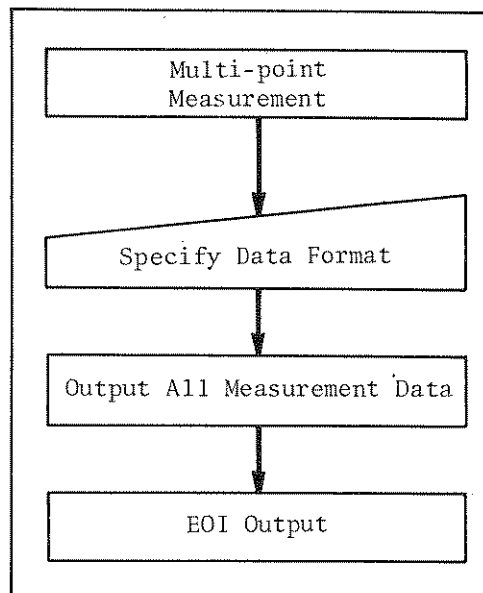

Figure 3-38. Block Data Transfer Mode

Note

When the 4280A is in block data transfer mode, *bl* is displayed on the C, G, and V-t displays, as shown below.



Note

If the 4280A is in REPEAT SWEEP MODE when block data transfer mode is set, SINGLE SWEEP MODE will be selected automatically. EXT SWEEP MODE, however, is not subject to this change.

3-198. Ho To Get Out Of Block Data Transfer Mode

3-199. The 4280A can be reset to standard data transfer mode in two ways: (1) by sending remote program code BL0 or (2) by pressing the LOCAL key, blue key, and then the CONNECTION MODE FLOATING key.

Note

ASCII format is automatically selected when the 4280A is reset to standard data transfer mode.

3-200. Number Of Measurement Points

3-201. Measurement function (C-G, C, G) determines the maximum number of measurement points possible for a C-V or C-t mode measurement made using block data transfer mode. Refer to Table 3-37.

Table 3-37. Number of Measurement Points When Block Data Transfer Mode Is Used

Measurement Function		
C-G	C	G
400 points	680 points	680 points

3-202. The number of measurement points is determined by the START V, STOP V, and STEP V parameters in C-V mode, and by the NO OF READINGS parameter in C-t mode.

3-203. If the number of measurement points for a C-V mode or C-t mode measurement exceeds the limit determined by the measurement function (see Table 3-37), the 4280A will terminate the measurement sequence when the maximum number of measurements have been made.

3-204. Outputting Measurement Data In Block Data Transfer Mode

3-205. To start block data transfer, one of the remote program codes listed in Table 3-38 must be sent after the last measurement has been performed.

Table 3-38. Program Codes For Outputting Block Data

Data Format	Remote Code
ASCII Format	BA or BD*
BINARY Format	BB

* Refer to paragraph 3-206 for the difference between BA and BD.

Note

If an instrument setting is changed after the measurement is completed but before block data transfer is started, the buffer memory will be cleared and all measurement data lost.

3-206. Output Data Formats In Block Data Transfer Mode

3-207. The output formats of measurement data in block data transfer mode are described below.

[ASCII Format]

C-V Mode

C-G Function:

C data	,	G data	,	V data	DELM
--------	---	--------	---	--------	------

C Function:

C data	,	V data	DELM
--------	---	--------	------

G Function:

G data	,	V data	DELM
--------	---	--------	------

C-t Mode

C-G Function:

C data	,	G data	,	T data	DELM
--------	---	--------	---	--------	------

C Function:

C data	,	T data	DELM
--------	---	--------	------

G Function:

G data	,	T data	DELM
--------	---	--------	------

Note

The DELM (delimiter) can be either a comma (,) or a carriage return/line feed (CR/LF) depending on which program code BA or BD was used to start block data transfer. See the table below.

Remote Code	DELM(delimiter)
BA	comma
BD	ⓄR ⓄF

Although comma (,) is selected, the last delimiter of a C-V mode or C-t mode measurement is always CR/LF.

Note

The EOI signal and the last line feed (LF) are output simultaneously.

Note

Refer to paragraph 3-189 for the contents of C, G, V and T data.

[BINARY mode]

C-V Mode or C-t Mode

C-G Function:

Status data	C data	G data	K data
-------------	--------	--------	--------

C Function:

Status data	C data	K data
-------------	--------	--------

G Function:

Status data	G data	K data
-------------	--------	--------

Note

The EOI signal and the byte of the last measurement data byte are output simultaneously.

Note

Refer to paragraph 3-191 for details on Status, C, G and K data.

3-208. STANDARD DATA TRANSFER MODE

3-209. In standard data transfer mode, the 4280A outputs measurement data at the end of each measurement. Unlike block data transfer mode, standard data transfer mode can be used in all three measurement modes (C mode, C-V mode, and C-t mode), and more measurement points are possible in C-V mode and C-t mode measurements.

3-210. Data Format In Standard Data Transfer Mode

3-211. To set the desired data format--ASCII or BINARY--send the appropriate remote program code (see Table 3-39) via the HP-IB before starting the measurement.

Table 3-39. Data Format Program Codes

Data Format	Remote Code
ASCII	AS
BINARY	BN

Note

It is necessary to specify the data format only when changing from one format to another. ASCII format (AS) is set at power on, after self test, and when "device clear" is received.

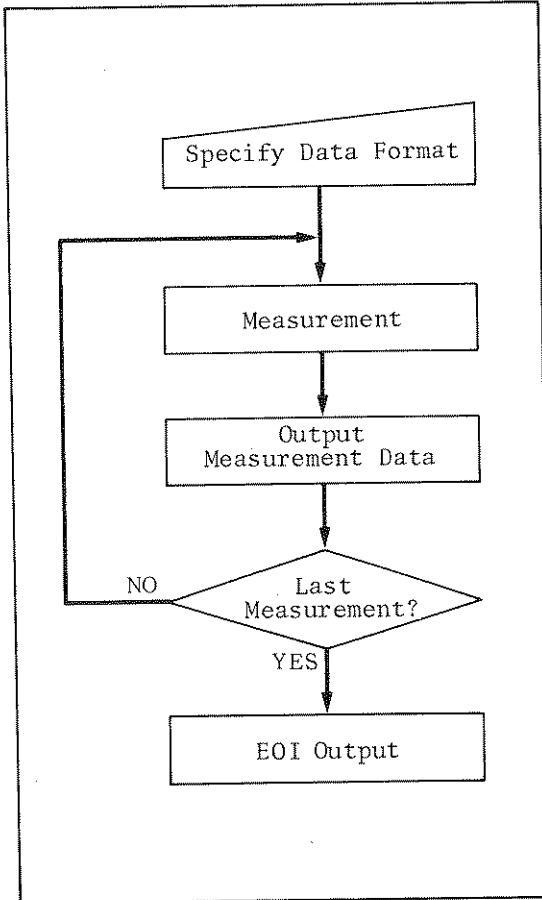

Figure 3-39. Standard Data Transfer Mode

3-212. Output Data Formats In Standard Data Transfer Mode

3-213. The output formats of measurement data in standard data transfer mode are described below.

[ASCII Format]

C Mode

C-G Function:

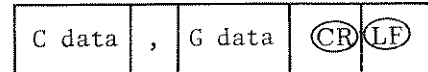

C Function:

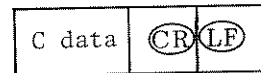

G Function:

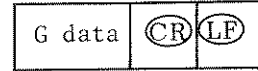

C-V Mode

C-G Function:

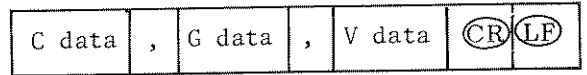

C Function:

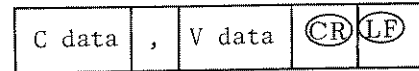

G Function:

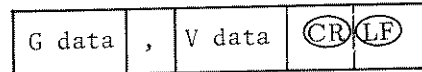

C-t Mode

C-G Function:

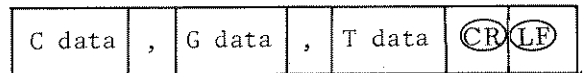

C Function:

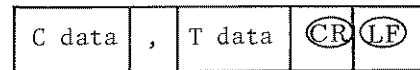

G Function:

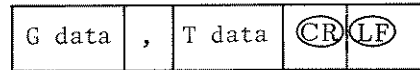

Note

L and R data (connection modes CN21, CN22, and CN23) for external error correction are output in the following format.



Note

In C mode the EOI signal and every line feed (LF) are output simultaneously. In C-V and C-t modes, however, the EOI signal is output with the line feed of the last measurement data.

Note

Refer to paragraph 3-188 for details on C, G, V, T, L and R data.

[BINARY Format]

C Mode

C-G Function:

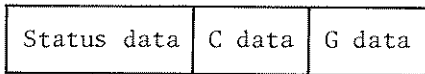

C Function:

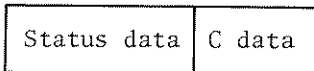

G Function:

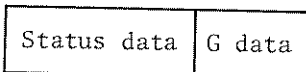

C-V and C-t Modes

C-G Function:

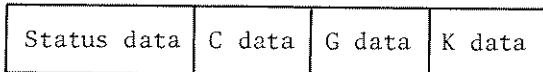

C Function:

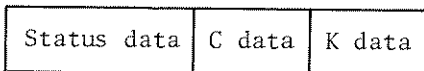

G Function:

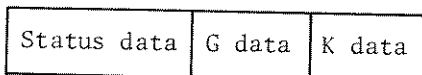

Note

L and R data cannot be output in BINARY format.

Note

The EOI signal is output with the last byte of measured data in C mode, and with the last byte of the final measurement in C-V or C-t mode.

Note

Refer to paragraph 3-190 for details on Status, C, G and K data.

3-214. ISOLATE FUNCTION

3-215. The isolate function does two things. It electrically isolates the internal measurement circuits from the HIGH and LOW UNKNOWN terminals and it turns off the test signal source. This function is used when the 4280A is part of a measurement system. With the isolate function turned on, the front end of the 4280A is completely isolated from the other system components. The isolate function can be turned on and off under remote control via the HP-IB or manually from the front panel. Remote program code IS1 turns the isolate function on; IS0 turns it off. While the isolate function is on, the 4280A will accept no remote program codes other than IS0. The procedure for manually turning the isolate function on and off is as follows.

- (1) Press the blue key. The lamp at the center of the key will light.
- (2) Press the SIG LEVEL key.
- (3) Press numeric key 1 if you're turning on the function, 0 if you're turning it off.
- (4) Press the ENTER key.

Note

When the isolate function is on, the C, G, and V-t displays will be as follows.

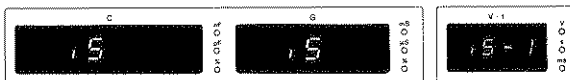

Note

Turning the isolate function on and off does not affect other control settings or parameter settings.

3-216. RESTRICTIONS ON CHANGING CONNECTION MODES

3-217. If the connection mode is changed while the internal dc bias source is outputting voltage (V OUTPUT lamp is lit), the internal dc bias source will be automatically turned off. When performing a measurement that requires the internal dc bias source, be sure to set the connection mode before turning on the internal dc bias source.

3-218. LEARN MODE

3-219. Learn mode is an HP-IB-related feature. Learn mode outputs the instrument's control settings, measurement status, error codes, etc. Table 3-40 lists the learn mode remote program codes and the data obtainable with each. Figure 3-40 show an example of using learn mode. Examples of using BS? are shown in sample programs 3, 4, 5, and 6 in Figure 3-42.

Note

BS? can be used only in block data transfer mode.

Note

Learn mode data is always output in ASCII format.

[ID?]

ID HP4280A, OPT $\frac{*}{(1)}$, ROM $\frac{*. *}{(2)}$ (CR) (LF)

(1) OPTION 001 Installation:

- 0: Not installed
- 1: Installed

(2) Control ROM Version Number:

1.0 (for example)

Note

The EOI signal is output with the (LF) signal.

Table 3-40. LEARN Mode

Remote Program Codes	Learn Mode Data Contents
ID?	Outputs the instrument's model number, option installation, and the ROM version.
MF?	Outputs the 4280A's Main Functions (measurement function, connection mode number, internal bias mode, etc.).
CF?	Outputs 4280A's Common Functions (measurement range, measurement speed, test signal level, etc.)
SET?	Output the 4280A's Main Functions and Common Functions (MF? and CF?).
ERR?	Outputs the most recent error code. Table 3-4 lists all error codes.
BS?	Outputs the number of measurement points and the measurement conditions in block data transfer mode.

```

10      ! LEARN MODE
20      DIM I$[26],M$[93],C$[76],S$[169],E$[8]
30      OUTPUT 717;"ID?"
40      ENTER 717;I$
50      PRINT I$
60      OUTPUT 717;"MF?"
70      ENTER 717;M$
80      PRINT M$
90      OUTPUT 717;"CF?"
100     ENTER 717;C$
110     PRINT C$
120     OUTPUT 717;"SET?"
130     ENTER 717;S$
140     PRINT S$
150     OUTPUT 717;"ERR?"
160     ENTER 717;E$
170     PRINT E$
180     END

```

Figure 3-40. LEARN Mode Program Example

[MF?]

C Mode or C-V Mode

$F\bar{N}_n$, $C\bar{N}n_n$, $I\bar{B}n$, $B\bar{L}n$, $V\bar{L}\pm*****$,
(1) (2) (3) (4) (5)

$P\bar{V}\pm*****$, $V\bar{O}n$, $P\bar{S}\pm*****$,
(6) (7) (8)

$P\bar{P}\pm*****$, $P\bar{E}\pm*****$, $P\bar{L}*****$
(9) (10) (11)



$E\pm*$, $P\bar{D}*****E\pm*$, $T\bar{R}n$ **CR** **LF**
(12) (13) (14) (15)

(1) Measurement Function:

- 1: C-G function (C-G or C-G-V measurement)
- 2: C function (C or C-V measurement)
- 3: G function (G or G-V measurement)

(2) Connection Mode Number

(3) Internal Bias Source Mode:

- | | | |
|--|---|----------|
| 0: OFF | } | C mode |
| 1: == | | |
| 2:  | } | C-V mode |
| 3:  | | |

(4) Data Transfer Mode:

- 0: Standard data transfer mode
- 1: Block data transfer mode

(5) V LIMIT Value (unit is V)

(6) DC V VALUE (unit is V)

(7) Internal Bias Source Status:

- 0: Off (no output)
- 1: On (output)

(8) START V Value (unit is V)

(9) STOP V Value (unit is V)

(10) STEP V Value (unit is V)

(11) HOLD TIME Value (displayed on V-t display)

(12) Unit of HOLD TIME Value (V-t display's unit indicator)

- 0: s (seconds)
- 3: ms (milliseconds)

(13) STEP DELAY TIME Value (displayed on V-t display)

(14) Unit of STEP DELAY TIME Value (V-t display's unit indicator)

- 0: s (seconds)
- 3: ms (milliseconds)

(15) TRIGGER or SWEEP MODE

- 1: INT/ **REPEAT**
- 2: EXT/ **EXT**
- 3: HOLD/MAN/ **SINGLE**

Note

If the 4280A is in C-V mode (IB 2 or 3 is selected), "VL + *****," is not output, because V LIMIT/RNG HOLD functions only in C mode.

Note

If the 4280A is performing an L-R measurement (CN21, C22, or 23 is selected), the contents of the learn mode data are the same as those for C mode.

C-t Mode

$F\bar{N}_n$, $C\bar{N}n_n$, $I\bar{B}n$, $B\bar{L}n$, $P\bar{U}\pm*****$,
(1) (2) (3) (4) (5)

$P\bar{M}\pm*****$, $P\bar{C}\pm*****$, $P\bar{N}*****$,
(6) (7) (8)

$P\bar{H}*****E\pm*$, $P\bar{T}*****E\pm*$, $S\bar{A}n$,
(9) (10) (11) (12) (13)

$T\bar{R}n$ **CR** **LF**
(14)

(1) Measurement Function

- 4: C-G function (C-G-t measurement)
- 5: C function (C-t measurement)
- 6: G function (G-t measurement)

- (2) Connection Mode Number
- (3) Internal Bias Source Mode
- 0: OFF
1: ==
2: Lr
- (external pulse bias source)
(internal pulse bias source)
- (4) Data Transfer Mode:
- 0: Standard data transfer mode
1: Block data transfer mode
- (5) PULSE V Value (unit is V)
- (6) MEAS V Value (unit is V)
- (7) DC V Value (unit is V)
- (8) NO OF READINGS
- (9) th Value (displayed on the V·t display)
- (10) Unit of th Value (V·t display's unit indicator):
- 0: s (seconds)
-3: ms (milliseconds)
- (11) td Value (displayed on the V·t display)
- (12) Unit of td Value (V·t display's unit indicator):
- 0: s (seconds)
-3: ms (milliseconds)
- (13) Integration Mode:
- 0: Burst mode
1: Sampling mode
- (14) SWEEP MODE
- 1: REPEAT
2: EXT
3: SINGLE

Note

The EOI signal is output with the (LF) signal.

[CF?]

$RM_n, RA_n, MS_n, SL_n, CH_n, LE_n,$
(1) (2) (3) (4) (5) (6)

$CE_n, MA_n, CR_{\pm*****E-12},$
(7) (8) (9)

$GR_{\pm*****E-6}, DC_n, DG_n, NN,$
(10) (11) (12) (13)

MD_n (CR) (LF)
(14)

(1) C·G RANGE:

- 1: 10pF/100 μ S
2: 100pF/1mS
3: 1nF/10mS

(2) Ranging Mode:

- 0: MANUAL
1: AUTO

(3) MEAS SPEED:

- 1: FAST
2: MED
3: SLOW

(4) SIG LEVEL:

- 1: 10mVrms
2: 30mVrms

(5) C-HIGH RESOLN (OPTION 001):

- 0: Not in use or not installed
1: In use

(6) CABLE LENGTH:

- 1: 0(m)
2: 1(m)
3: 0 - 5(m)

(7) ERROR CORRECTION:

- 0: Disabled
1: Enabled

- (8) MATH:
 - 0: Not in use
 - 1: Δ measurement
 - 2: % measurement
 - 3: $\Delta\%$ measurement
- (9) C-REF Value (unit is pF)
- (10) G-REF Value (unit is μS)
- (11) DIGIT SHIFT C \diamond . Number of digit shifts.
- (12) DIGIT SHIFT G \diamond . Number of digit shifts.
- (13) Data Format:
 - AS: ASCII
 - BN: BINARY
- (14) Data Ready SRQ Mask:
 - 0: Data Ready SRQ is disabled.
 - 1: Data Ready SRQ is enabled (when the Data Ready bit (bit 0) of the status byte is set, the RQS bit (bit 6) is also set.)

Note

The EOI signal is output with the LF signal.

[SET?]

MF? data, CF? data CR LF

Note

The EOI signal is output with the LF signal.

[ERR?]

ER *** CR LF
(1)

- (1) Operation Error Code (see Table 3-4)

If no error has occurred, 00.0 is output.

Note

ERR? outputs the error code of the error that occurred before ERR? was sent. If a second error occurs between the time ERR? was sent and the time the learn mode data was read (ENTER), the second error will be ignored.

Note

The EOI signal is output with the LF signal.

[BS?]

NM ****, CE *, CH *, MA * CR LF
(1) (2) (3) (4)

- (1) Number of Measurement Points
- (2) ERROR CORRECTION:
 - 0: Disabled
 - 1: Enabled
- (3) C-HIGH RESOLN (OPTION 001):
 - 0: Not in use
 - 1: In use
- (4) MATH:
 - 0: Not in use
 - 1: Δ measurement
 - 2: % measurement
 - 3: $\Delta\%$ measurement

Note

If, while the 4280A is in block data transfer mode, BS? is sent before the completion of the measurement, the binary output data may be incorrect.

3-220. SERVICE REQUEST STATUS BYTE

3-221. The 4280A outputs an SRQ (Service Request) signal whenever it is set to one of six possible service request states. When serial polling is performed, the Status Byte is transferred to the controller via the eight DIO lines of the HP-IB. Figure 3-41 shows the contents of the Status Byte. Bit 0 (Data Ready bit) of the Status Byte can be masked (disabled) so that bit 6 (RQS) is not set each time bit 0 is set. When the 4280A is turned on, the Data Ready bit is masked.

Bit	7	6	5	4	3	2	1	0
DIO Line	8	7	6	5	4	3	2	1
Decimal Value	128	64	32	16	8	4	2	1
Content		RQS	Sweep/ Bias Error	Illegal Program	Trigger Too Fast	Self Test End	Syntax Error	Data Ready

Bit 6 (RQS) indicates whether or not a service request exists. Bit 7 is always zero (0). Bits 0 through 5 identify the type of service request. Following are the service request states of the 4280A:

(1) Bit 0: Data Ready (maskable)

This bit is set when measurement data is ready for output (in standard data transfer mode), and when a C-V or C-t measurement is completed (in block data transfer mode). This bit is reset when the first byte of measurement data has been output, and when learn mode data is ready for output.

Note

The Data Ready bit is not set when learn mode data is ready for output.

(2) Bit 1: Syntax Error

This bit is set when the remote program contains a syntax error.

(3) Bit 2: Self Test End

This bit is set when the first cycle of the Self Test has been completed without an error.

(4) Bit 3: Trigger Too Fast

This bit is set when the 4280A is externally triggered before the measurement has been completed.

Figure 3-41. 4280A Status Byte (Sheet 1 of 2)

(5) Bit 4: Illegal Program

This bit is set whenever an illegal operation is performed.

(6) Bit 5: Sweep/Bias Error

This bit is set when remote program code SW1 or VO1 was sent under one of the following conditions.

(a) Output voltage exceeds the INT BIAS switch setting (Paragraph 3-48).

(b) td value is too short in burst mode (C-t mode).

(c) td and th values are incompatible for sampling mode (C-t mode).

(7) Bit 6: RQS (Request Service)

This bit is set whenever one of the six bits described above is set.

Note

The Data Ready bit, bit 0, is masked at power on and after remote program code MD0 has been sent. This prevents bit 6 from being set when bit 0 is set. To enable Data Ready SRQ, send remote program code MD1.

Note

All seven bits are reset when serial polling is performed, when device clear is performed, or when self test is released.

Figure 3-41. 4280A Status Byte (Sheet 2 of 2)

3-222. 4280A PROGRAMMING GUIDE

Table 3-41. Sample Programs

3-223. The sample programs shown in Figure 3-42 can be run directly on HP series 200 computers (HP9816, 9920, 9826, 9836) with the BASIC 2.0 language system. These programs are listed in Table 3-41.

Note

Controller-specific HP-IB programming information is given in the controller's programming manual.

Sample Program	Description
1	C mode ASCII output (single - bias)
2	C mode binary output (multi - bias)
3	C-V mode ASCII (long STEP DELAY TIME)
4	C-V mode binary (short STEP DELAY TIME)
5	C-V mode block data transfer mode measurement routine
6	Internal bias C-t measurement with block data transfer mode.
7	Ext bias FAST C-t measurement with block data transfer mode.
8	Block data transfer routine (ASCII "BD").
9	Block data transfer routine (ASCII "BA").
10	Block data transfer routine (binary).
11	Internal error correction (0m) routine.
12	Internal error correction (0-5m) routine.
13	Binary conversion routine.

Table 3-42. Data Transmission Times

Controller	Data Format	C Mode			C-V Mode			C-t Mode		
		C	G	C · G	C	G	C · G	C	G	C · G
HP 9825A	ASCII	13	12	22	18.3	17.3	27.3	19.6	18.6	28.6
	BINARY	3.4		4.8	4.8		6.2	4.8		6.2
HP 9826	ASCII	13	12	22	18.3	17.3	27.3	19.6	18.6	28.6
	BINARY	5		7	6.8		8.8	6.8		8.8
HP 9835A	ASCII	28	27	38	33.3	32.3	43.3	34.6	33.6	44.6
	BINARY	20		21	20.8		21.8	20.8		21.8
HP 9845B	ASCII	22	21	32	27.3	26.3	37.3	28.6	27.6	38.6
	BINARY	13		15	14.4		16.4	14.4		16.4

(All times are in milliseconds)

[Sample Program 1]

```
10  Hp4280a=717
20  CLEAR Hp4280a
30  OUTPUT Hp4280a;"TR3"
40  GOSUB Int_correct
50  OUTPUT Hp4280a;"PV5"
60  OUTPUT Hp4280a;"VD1"
70  OUTPUT Hp4280a;"BC"
80  OUTPUT Hp4280a;"EX"
90  ENTER Hp4280a;C,G
100 OUTPUT Hp4280a;"VD0"
110 PRINT C,G
120 STOP
```

} Subroutines

END

10: Assigns the value 717 to variable Hp4280a, which is used as the device address for all I/O statements in the program. Here, the first 7 is the controller's HP-IB select code, and 17 is the 4280A's HP-IB address.

20: Clears the 4280A and establishes initial settings.

30: Sets the 4280A's trigger mode to HOLD/MAN.

40: Calls an internal error correction routine, such as Sample Program 11 or 12, which, if used, must be linked to this program. If internal error correction is not to be used, change this line as shown below.

```
40  OUTPUT Hp4280a;"CE0"
```

50: Sets the output from the internal dc bias source to +5V.

60: Outputs the specified bias voltage from the internal dc bias source.

70: Clears the 4280A's data output buffer.

80: Triggers the 4280A. This is equivalent to: TRIGGER Hp4280a

90: Reads measured capacitance and conductance values.

100: Turns off the internal dc bias source.

110: Prints the measurement results in farads(F) and siemens(S).

120: Stops the program.

Figure 3-42. Sample Programs (Sheet 1 of 12)

[Sample Program 2]

```

10   Hp4280a=717
20   DATA 1.0,1.6,2.5,4.0,6.3,10.0,15.8,25.1,39.8
30   CLEAR Hp4280a
40   OUTPUT Hp4280a;"TR3.BC"
50   OUTPUT Hp4280a;"BN"
60   OUTPUT Hp4280a;"VL40"
70   OUTPUT Hp4280a;"VD1"
80   RESTORE
90   FOR I=1 TO 9
100  READ Dc_v
110  OUTPUT Hp4280a;"PV";Dc_v
120  WAIT .5 ! DELAY TIME
130  OUTPUT Hp4280a;"EX"
140  ENTER Hp4280a USING "#,B,W,W";S,C,G
150  GOSUB Binary_to_value
160  PRINT S,C,G,Dc_v
170  NEXT I
180  OUTPUT Hp4280a;"V00"
190  STOP
    { Subroutines
      END

```

20: Data for a logarithmic bias voltage sweep.

50: Sets the 4280A's data output format to binary.

60: Sets bias voltage limits to $\pm 40V$ and sets the bias range to the 100V range.

140: Reads the status data, the measured capacitance (counts), and the measured conductance(counts).

150: Calls a binary-to-value conversion routine, such as Sample Program 13, which, if used, must be linked with this program. If conversion is not needed, delete this line.

Note

Internal error correction does not function when the 4280A is set to binary output format.

Figure 3-42. Sample Programs (Sheet 2 of 12)

[Sample Program 3]

```

10   Hp4280a=717
20   CLEAR Hp4280a
30   OUTPUT Hp4280a;"TR3"
40   OUTPUT Hp4280a;"IB2"
50   GOSUB Int_correct
60   OUTPUT Hp4280a;"PS-5"
70   Stop_v=5
80   OUTPUT Hp4280a;"PP";Stop_v
90   OUTPUT Hp4280a;"PE.5"
100  OUTPUT Hp4280a;"PL10"
110  OUTPUT Hp4280a;"PD3"
120  OUTPUT Hp4280a;"BC"
130  OUTPUT Hp4280a;"SW1"
140  Read_data:!
150  ENTER Hp4280a;C,G,V
160  PRINT C,G,V
170  IF V=Stop_v THEN Sweep_end
180  GOTO Read_data
190  Sweep_end:!
200  STOP

    { Subroutines
      END

```

40: Sets the internal dc bias source to single-staircase (μ) sweep mode.

60: Sets START V to -5V.

70: Assigns the value 5 to variable Stop_v.

80: Sets STOP V to Stop_v (+5V).

90: Sets STEP V to 0.5V.

100: Sets HOLD TIME to 10s.

110: Sets STEP DELAY TIME to 3s.

130: Starts the measurement.

140 ~ 180: Reads and prints measurement results until the bias voltage reaches the Stop_v value.

Figure 3-42. Sample Programs (Sheet 3 of 12)

[Sample Program 4]

```

10  OPTION BASE 1
20  DIM S(21),C(21),G(21),Vtk(21)
30  I=0
40  Hp4280a=717
50  CLEAR Hp4280a
60  OUTPUT Hp4280a;"TR3,IB2"
70  OUTPUT Hp4280a;"BN"
80  OUTPUT Hp4280a;"PS-5,PP5,PE.5,PL1,PD.3"
90  OUTPUT Hp4280a;"BC"
100 OUTPUT Hp4280a;"SW1"
110 Read_data:!  

120  I=I+1
130  ENTER Hp4280a USING "#,B,W,W,W";S(I),C(I),G(I),Vtk(I)
140  IF BIT(S(I),6)=1 THEN GOTO Print_out
150  GOTO Read_data
160 Print_out:!  

170  FOR J=1 TO I
180    PRINT S(J),C(J),G(J),Vtk(J)
190  NEXT J
200  END

```

110 ~ 150: Read data in binary format until bit 6 of the status data (final data bit) is set.

160 ~ 190: Prints out all measurement data.

Figure 3-42. Sample Programs (Sheet 4 of 12)

[Sample Program 5]

```

10  OPTION BASE 1
20  DIM S(21),C(21),G(21),Vtk(21)
30  Srq=2
40  Data_ready=0
50  Hp4280a=717
60  ON INTR 7 GOTO Sweep_end
70  CLEAR Hp4280a
80  OUTPUT Hp4280a;"TR3,BC,IB2"
90  GOSUB Int_correct
100 OUTPUT Hp4280a;"BL1"
110 OUTPUT Hp4280a;"PS-5,PP5,PE.5,PL3E-3,PD3E-3"
120 OUTPUT Hp4280a;"MD1"
130 OUTPUT Hp4280a;"SW1"
140 ENABLE INTR 7;Srq
150 Idle_block_meas:
160 GOTO Idle_block_meas
170 Sweep_end:
180 Status_byte=SPOLL(Hp4280a)
190 DISP "STATUS BYTE= ",Status_byte
200 IF BIT(Status_byte,Data_ready)=1 THEN
210   OUTPUT Hp4280a;"BS?"
220   ENTER Hp4280a;Nm,Ce,Ch,Ma
230   GOTO Read_data
240 ELSE
250   PRINT "Service Request other than DATA READY"
260   STOP
270 END IF

```

30: Assigns the value 2 to the variable Srq, which is used as the bit mask of the ENABLE INTR statement (line 140).

40: Assigns the value 0 to the variable Data_ready, which is used in the service routine Sweep_end to check the data ready bit, bit 0, of the 4280A's status byte.

60: Defines the service routine to be executed when the 4280A generates a service request.

100: Sets the 4280A to BLOCK data transfer mode.

120: Instructs the 4280A to set the data ready bit, bit0, and the SRQ bit, bit6, of the status byte when measurement data is ready for output.

140: Enables the HP-IB interface to generate an SRQ interrupt.

150 and 160: Infinite loop. The computer idles until an HP-IB interrupt occurs.

180: Reads the 4280A's status byte.

190: Displays the decimal equivalent of the value stored in the 4280A's status byte.

Figure 3-42. Sample Programs (Sheet 5 of 12)

- 200 ~ 230: Check bit 0 of the 4280A's status byte. If bit 0 is set, the measurement was successfully completed. The controller will read the measurement conditions (lines 210 and 220) and then will invoke a read data routine (examples of which are given in sample programs 8, 9 and 10).
- 240 ~ 260: Terminates the program if bit 0 of the status byte was not set, indicating an SRQ was generated for some other reason.

Note

Sample program 8, 9, or 10 must be linked to this program to read the measurement data.

Figure 3-42. Sample Programs (Sheet 6 of 12)

[Sample Program 6]

```

10  OPTION BASE 1
20  DIM S(21),C(21),G(21),Vtk(21)
30  Srq=2
40  Data_ready=0
50  Hp4280a=717
60  ON INTR 7 GOTO Sweep_end
70  CLEAR Hp4280a
80  OUTPUT Hp4280a;"TR3,BC"
90  OUTPUT Hp4280a;"FN4"
100 GOSUB Int_correct
110 OUTPUT Hp4280a;"RM3"
120 OUTPUT Hp4280a;"BL1"
130 OUTPUT Hp4280a;"PU5"
140 OUTPUT Hp4280a;"PM-5"
150 OUTPUT Hp4280a;"PN21"
160 OUTPUT Hp4280a;"PH1"
170 OUTPUT Hp4280a;"PT250E-3"
180 OUTPUT Hp4280a;"MD1"
190 OUTPUT Hp4280a;"SW1"
200 ENABLE INTR 7;Srq
210 Idle_block_meas:
220 GOTO Idle_block_meas
230 Sweep_end:
240 Status_byte=SPOLL(Hp4280a)
250 DISP "STATUS BYTE= ",Status_byte
260 IF BIT(Status_byte,Data_ready)=1 THEN
270   OUTPUT Hp4280a;"BS?"
280   ENTER Hp4280a;Nm,Ce,Ch,Ma
290   GOTO Read_data
300 ELSE
310   PRINT "Service Request other than DATA READY"
320   STOP
330 END IF

```

90: Sets the 4280A to C-t mode.

110: Sets the measurement range to the lnF/10mS range.

130: Sets PULSE V to +5V.

140: Sets MEAS V to -5V.

150: Sets NO OF READINGS to 21.

160: Sets th to 1s.

170: Sets td to 250ms.

Note

Sample program 8, 9, or 10 must be linked to this program to read the measurement data.

Figure 3-42. Sample Programs (Sheet 7 of 12)

[Sample Program 7]

```

10  OPTION BASE 1
20  DIM S(21),C(21),G(21),Vtk(21)
30  Srq=2
40  Data_ready=0
50  Hp4280a=717
60  ON INTR 7 GOTO Sweep_end
70  CLEAR Hp4280a
80  OUTPUT Hp4280a;"TR3,BC"
90  OUTPUT Hp4280a;"FN4"
100 OUTPUT Hp4280a;"CN13"
110 OUTPUT Hp4280a;"IB0"
120 GOSUB Int_correct
130 OUTPUT Hp4280a;"RM3"
140 OUTPUT Hp4280a;"BL1"
150 OUTPUT Hp4280a;"PN21"
160 OUTPUT Hp4280a;"PH100E-6"
170 OUTPUT Hp4280a;"PT10E-6"
180 OUTPUT Hp4280a;"MD1"
190 OUTPUT Hp4280a;"SW1"
200 ENABLE INTR 7;Srq
210 Idle_block_meas:!
220 GOTO Idle_block_meas
230 Sweep_end:!
240 Status_byte=SPOLL(Hp4280a)
250 DISP "STATUS BYTE= ",Status_byte
260 IF BIT(Status_byte,Data_ready)=1 THEN
270   OUTPUT Hp4280a;"BS?"
280   ENTER Hp4280a;Nm,Ce,Ch,Ma
290   GOTO Read_data
300 ELSE
310   PRINT "Service Request other than DATA READY"
320   STOP
330 END IF

```

100: Sets the 4280A's connection mode to CN13.

110: Sets the 4280A's internal dc bias source to OFF.

Note

Sample program 8, 9, or 10 must be linked to this program to read measurement data.

Figure 3-42. Sample Programs (Sheet 8 of 12)

[Sample Program 8]

```

1010 Read_data:!
1020 OUTPUT Hp4280a;"BD"
1030 FOR I=1 TO Nm
1040   ENTER Hp4280a;C(I),G(I),Vtk(I)
1050 NEXT I
1060 Print_out:!
1070 FOR I=1 TO Nm
1080   PRINT C(I),G(I),Vtk(I)
1090 NEXT I
1100 STOP

```

} Subroutines
END

1020: Instructs the 4280A to output measurement data in BLOCK data transfer mode and in ASCII format.

[Sample Program 9]

```

1010 Read_data:!
1020 OUTPUT Hp4280a;"BA"
1030 FOR I=1 TO Nm
1040   ENTER Hp4280a USING "#,K,K,K";C(I),G(I),Vtk(I)
1050 NEXT I
1060 Print_out:!
1070 FOR I=1 TO Nm
1080   PRINT C(I),G(I),Vtk(I)
1090 NEXT I
1100 STOP

```

} Subroutines
END

1020: Instruct the 4280A to output measurement data in ASCII format.

[Sample Program 10]

```

1010 Read_data:!
1020 OUTPUT Hp4280a;"BB"
1030 FOR I=1 TO Nm
1040   ENTER Hp4280a USING "#,B,W,W,W";S(I),C(I),G(I),Vtk(I)
1050 NEXT I
1060 Print_out:!
1070 FOR I=1 TO Nm
1080   PRINT S(I),C(I),G(I),Vtk(I)
1090 NEXT I
1100 STOP

```

} Subroutines
END

1020: Instructs the 4280A to output measurement data in binary format.

Figure 3-42. Sample Programs (Sheet 9 of 12)

[Sample Program 11]

```
1010 Int_correct:!  
1020 Srq=2  
1030 Data_ready=0  
1040 Status_byte=0  
1050 ON INTR 7 GOSUB Cal_end  
1060 DISP "DISCONNECT DUT"  
1070 PAUSE  
1080 OUTPUT Hp4280a;"LE1"  
1090 OUTPUT Hp4280a;"MD1"  
1100 ENABLE INTR 7;Srq  
1110 OUTPUT Hp4280a;"Z0"  
1120 Idle_open:!  
1130 IF BIT(Status_byte,Data_ready)=1 THEN GOTO Zero_open_end  
1140 GOTO Idle_open  
1150 Zero_open_end:!  
1160 OUTPUT Hp4280a;"MD0"  
1170 OUTPUT Hp4280a;"CE1"  
1180 DISP "CONNECT DUT"  
1190 PAUSE  
1200 RETURN  
1210 Cal_end:!  
1220 Status_byte=SPOLL(Hp4280a)  
1230 DISP "STATUS BYTE= ";Status_byte  
1240 ENABLE INTR 7;Srq  
1250 RETURN
```

1080: Selects the 0m cable length setting.

1110: Initiates ZERO OPEN measurement.

1120 ~ 1140: Waits until ZERO OPEN measurement ends.

1170: Enables the internal error correction function.

Figure 3-42. Sample Programs (Sheet 10 of 12)

[Sample Program 12]

```

1010 Int_correct:!!
1020   Srq=2
1030   Data_ready=0
1040   Status_byte=0
1050   ON INTR 7 GOSUB Cal_end
1060   DISP "CONNECT TEST LEADS"
1070   PAUSE
1080   OUTPUT Hp4280a;"LE3"
1090   OUTPUT Hp4280a;"MD1"
1100   ENABLE INTR 7;Srq
1110   OUTPUT Hp4280a;"CA"
1120 Idle_cable:!
1130   IF BIT(Status_byte,Data_ready)=1 THEN GOTO Zero_open
1140   GOTO Idle_cable
1150 Zero_open:!
1160   Status_byte=0
1170   DISP "CONNECT TEST FIXTURE"
1180   PAUSE
1190   OUTPUT Hp4280a;"Z0"
1200 Idle_open:!
1210   IF BIT(Status_byte,Data_ready)=1 THEN GOTO Zero_open_end
1220   GOTO Idle_open
1230 Zero_open_end:!
1240   OUTPUT Hp4280a;"MD0"
1250   OUTPUT Hp4280a;"CE1"
1260   DISP "CONNECT DUT"
1270   PAUSE
1280   RETURN
1290 Cal_end:!
1300   Status_byte=SPOLL(Hp4280a)
1310   DISP "STATUS BYTE= ";Status_byte
1320   ENABLE INTR 7;Srq
1330   RETURN

```

1060: Prompts the operator to connect the test leads to the 4280A's UNKNOWN terminals. Connect nothing to the measurement ends of the test leads.

1110: Initiates cable length calibration.

1170: Prompts the operator to connect the test fixture to the test leads. The outer conductor of the HIGH and LOW leads should be connected together at the test fixture.

Figure 3-42. Sample Programs (Sheet 11 of 12)

[Sample Programs 13]

```
1010 Binary_to_value:!  
1020 S7$=""  
1030 S6$=""  
1040 Full_scale=1000  
1050 IF BIT(S,7)=1 THEN S7$="DATA INVALID"  
1060 IF BIT(S,6)=1 THEN S6$="FINAL DATA"  
1070 IF BIT(S,3)=1 THEN Full_scale=10000  
1080 IF BIT(S,2)=1 THEN  
1090     C_range=1.E-9  
1100     G_range=1.E-2  
1110 END IF  
1120 IF BIT(S,1)=1 THEN  
1130     C_range=1.E-10  
1140     G_range=1.E-3  
1150 END IF  
1160 IF BIT(S,0)=1 THEN  
1170     C_range=1.E-11  
1180     G_range=1.E-4  
1190 END IF  
1200 C=C*C_range/Full_scale  
1210 G=G*G_range/Full_scale  
1220 RETURN
```

This sample program converts capacitance and conductance counts into capacitance and conductance values in farads (F) and siemens (S), respectively.

Figure 3-42. Sample Programs (Sheet 12 of 12)

